

2

# NAVAL POSTGRADUATE SCHOOL Monterey, California

AD-A246 754  



DTIC  
ELECTE  
MAR 03 1992  
S B D

## THESIS

THE ELECTROMAGNETIC PULSE ENVIRONMENT  
AND ITS INFLUENCE ON TACTICAL  
ELECTRONIC AND COMMUNICATIONS EQUIPMENT

by

Steven J. McGrath

March 1992

Thesis Advisor:

Dan C. Boger

Approved for public release; distribution is unlimited

92 2 28 0117

92-05255



REPORT DOCUMENTATION PAGE				Approved FORM 101-018-01RR	
1a REPORT SECURITY CLASSIFICATION <b>UNCLASSIFIED</b>			1b RESTRICTIVE MARKINGS		
2a SECURITY CLASSIFICATION AUTHORITY			3 DISTRIBUTION AVAILABILITY OF REPORT <b>Approved for public release; distribution is unlimited</b>		
2b DECLASSIFICATION/DOWNGRADING SCHEDULE					
4 PERFORMING ORGANIZATION REPORT NUMBER(S)			5 MONITORING ORGANIZATION REPORT NUMBER(S)		
6a NAME OF PERFORMING ORGANIZATION <b>Naval Postgraduate School</b>		6b OFFICE SYMBOL (if applicable) <b>AS</b>	7a NAME OF MONITORING ORGANIZATION <b>Naval Postgraduate School</b>		
6c ADDRESS (City, State, and ZIP Code) <b>Monterey, CA 93943-5000</b>			7b ADDRESS (City, State, and ZIP Code) <b>Monterey, CA 93943-5000</b>		
8a NAME OF FUNDING SPONSORING ORGANIZATION		8b OFFICE SYMBOL (if applicable)	9 ACQUISITION INSTRUMENT IDENTIFICATION NUMBER		
8c ADDRESS (City, State, and ZIP Code)			10 SOURCE OF FUNDING NUMBERS		
			PROGRAM ELEMENT NO	PROJECT NO	TASK NO
			WORK UNIT ACCESSION NO		
11 TITLE (Include Security Classification) <b>THE ELECTROMAGNETIC PULSE ENVIRONMENT AND ITS INFLUENCE ON TACTICAL ELECTRONIC AND COMMUNICATIONS EQUIPMENT</b>					
12 PERSONAL AUTHOR(S) <b>MCGRATH, Steven J.</b>					
13a TYPE OF REPORT <b>Master's Thesis</b>		13b TIME COVERED FROM TO	14 DATE OF REPORT (Year, Month, Day) <b>1992 March</b>		15 PAGE COUNT <b>95</b>
16 SUPPLEMENTARY NOTES <b>The views expressed in this thesis are those of the author and do not reflect the official policy or position of the Department of Defense or the US Government.</b>					
17 COSATI CODES			18 SUBJECT TERMS (Continue on reverse if necessary and identify by block number)		
FIELD	GROUP	SUBGROUP	<b>Electromagnetic Pulse; EMP</b>		
19 ABSTRACT (Continue on reverse if necessary and identify by block number) <b>The purpose of this thesis is to aid the military communicator in understanding the phenomenon that is known as the electromagnetic pulse (EMP). This thesis includes a brief history and definition of the EMP and a description of the various EMP environments. It also discusses the effects that an EMP can have on exposed electronic components and communications equipment. It provides a description of the major approaches that are used to reduce the harmful effects of an EMP. A discussion of the factors considered in a cost/benefit analysis is included for the purpose of establishing cost and benefit considerations relevant to a system's evaluation. The thesis concludes that the decision of whether or not to protect electronic and communications equipment from an EMP depends on many factors, including the criticality of the equipment's mission and the cost of EMP hardening compared to the benefits received. It also concludes that the nation should maintain its EMP hardening effort for critical systems.</b>					
20 DISTRIBUTION AVAILABILITY OF ABSTRACT <input checked="" type="checkbox"/> UNCLASSIFIED//FOR PUBLIC USE <input type="checkbox"/> SAME AS RPT <input type="checkbox"/> DEC USERS			21 ABSTRACT SECURITY CLASSIFICATION <b>UNCLASSIFIED</b>		
22 NAME OF AUTHOR <b>BOGER, Dan C.</b>			23 AUTHORING ORGANIZATION <b>408-646-2067</b>		24 AUTHOR CENTER <b>AS/Bo</b>

Approved for public release; distribution is unlimited.

The Electromagnetic Pulse Environment and its Influence  
on Tactical Electronic and Communications Equipment

by

Steven J. McGrath  
Captain, United States Marine Corps  
BBA, University of Oklahoma

Submitted in partial fulfillment  
of the requirements for the degree of

MASTER OF SCIENCE IN TELECOMMUNICATIONS  
SYSTEMS MANAGEMENT

from the

NAVAL POSTGRADUATE SCHOOL  
March 1992

Author:

  
\_\_\_\_\_  
Steven J. McGrath

Approved by:

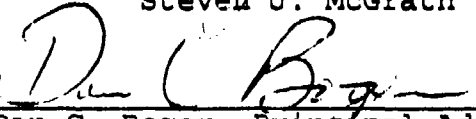
  
\_\_\_\_\_  
Dan C. Boger, Principal Advisor

  
\_\_\_\_\_  
Donald E. Summers, Associate Advisor

  
\_\_\_\_\_  
David R. Whipple, Jr., Chairman  
Department of Administrative Sciences

## ABSTRACT

The purpose of this thesis is to aid the military communicator in understanding the phenomenon that is known as the electromagnetic pulse (EMP). This thesis includes a brief history and definition of the EMP and a description of the various EMP environments. It also discusses the effects that an EMP can have on exposed electronic components and communications equipment. It provides a description of the major approaches that are used to reduce the harmful effects of an EMP. A discussion of the factors considered in a cost/benefit analysis is included for the purpose of establishing cost and benefit considerations relevant to a system's evaluation. The thesis concludes that the decision of whether or not to protect electronic and communications equipment from an EMP depends on many factors, including the criticality of the equipment's mission and the cost of EMP hardening compared to the benefits received. It also concludes that the nation should maintain its EMP hardening effort for critical systems.



Accession For	
NTIS GRA&I	<input checked="" type="checkbox"/>
DTIC TAB	<input type="checkbox"/>
Unannounced	<input type="checkbox"/>
Justification	
By _____	
Distribution/	
Availability Codes	
DTIC	Special

A-1

TABLE OF CONTENTS

I. INTRODUCTION . . . . . 1

    A. BACKGROUND . . . . . 1

    B. PURPOSE . . . . . 2

    C. THESIS OUTLINE . . . . . 3

II. THE ELECTROMAGNETIC PULSE . . . . . 5

    A. INTRODUCTION . . . . . 5

    B. EMP GENERATION . . . . . 5

    C. EMP ENVIRONMENTS . . . . . 8

        1. Subsurface Burst EMP . . . . . 10

        2. Surface Burst EMP . . . . . 10

        3. Air Burst EMP . . . . . 12

        4. High Altitude Burst EMP . . . . . 14

        5. Magnetohydrodynamic EMP . . . . . 16

        6. Transient Radiation Effects In  
            Electronics . . . . . 18

        7. System Generated EMP . . . . . 18

    D. SUMMARY . . . . . 20

III. ELECTROMAGNETIC PULSE EFFECTS . . . . . 21

    A. INTRODUCTION . . . . . 21

    B. COUPLING . . . . . 22

1. Diffusion . . . . .	24
2. Leakage . . . . .	25
3. Apertures . . . . .	25
4. Penetrations . . . . .	25
5. Coupling To Aircraft . . . . .	25
6. Coupling To Ships . . . . .	27
7. Coupling To Ground-Based Systems . . . . .	29
C. EMP EFFECTS ON ELECTRONIC EQUIPMENT . . . . .	30
1. Component Damage . . . . .	32
a. Dielectric Breakdown . . . . .	34
b. Thermal Effect . . . . .	34
c. Interconnection Failure . . . . .	34
2. Component Upset . . . . .	34
3. EMP Effects On Electrical Cables . . . . .	36
D. RADIO BLACKOUT . . . . .	37
E. SUMMARY . . . . .	38

IV. HARDENING EQUIPMENT TO THE ELECTROMAGNETIC PULSE . . . . .	40
A. INTRODUCTION . . . . .	40
B. DEFINING HARDENING . . . . .	40
1. Requirements . . . . .	41
2. Approach To System Hardening . . . . .	44
C. REDUCING THE EMP ENVIRONMENT . . . . .	44
1. Strategy . . . . .	44
2. Shielding . . . . .	47

3. Apertures . . . . .	50
4. Penetrations . . . . .	51
5. Grounding . . . . .	54
D. RAISING SYSTEM THRESHOLD . . . . .	55
E. SELECTING A HARDENING APPROACH . . . . .	56
F. FIELD PROTECTIVE MEASURES . . . . .	58
G. SYSTEM TESTING . . . . .	59
H. SUMMARY . . . . .	60

V. ELECTROMAGNETIC PULSE HARDENING: COSTS AND BENEFITS . . . . .	61
A. INTRODUCTION . . . . .	61
B. ESTIMATING EMP HARDENING COSTS . . . . .	61
C. TACTICAL SYSTEM LIFE CYCLE COSTS . . . . .	64
1. Identifying the Threat . . . . .	64
2. Testing (Surveillance) . . . . .	65
3. Research and Development . . . . .	66
4. Manufacturing and Production . . . . .	66
5. Training and Personnel . . . . .	67
6. Development and Production of Support Equipment . . . . .	67
D. STATIONARY SYSTEM LIFE CYCLE COSTS . . . . .	68
E. LIFE CYCLE COST CONSIDERATIONS . . . . .	69
1. Acquisition Costs . . . . .	70
2. Operation Costs . . . . .	70
3. Logistic Support Costs . . . . .	70

F.	EMP HARDENING BENEFITS . . . . .	71
G.	COST/BENEFIT ANALYSIS . . . . .	72
	1. Probability Model . . . . .	72
	2. Cost Effectiveness Model . . . . .	74
H.	SUMMARY . . . . .	76
VI.	SUMMARY AND CONCLUSIONS . . . . .	77
	A. SUMMARY . . . . .	77
	B. CONCLUSIONS . . . . .	79
	LIST OF REFERENCES . . . . .	81
	INITIAL DISTRIBUTION LIST . . . . .	84



## LIST OF FIGURES

Figure 1. Nuclear Detonation Environments .....	6
Figure 2. Creation of an Electromagnetic Pulse .....	8
Figure 3. EMP Environments .....	9
Figure 4. Surface Burst EMP .....	12
Figure 5. High Altitude EMP Ground Coverage .....	15
Figure 6. HEMP Source Region .....	17
Figure 7. All Conductors Act Like Antennas .....	24
Figure 8. EMP Coupling to Systems .....	26
Figure 9. EMP Coupling to Aircraft .....	27
Figure 10. EMP Coupling to Ships .....	28
Figure 11. EMP Coupling to Ground Vehicles .....	31
Figure 12. Results of EMP Interaction with Systems .....	32
Figure 13. EMP Effects on Electronics .....	35
Figure 14. Major Hardening Requirement Decisions .....	42
Figure 15. Multibarrier EMP Hardening .....	46
Figure 16. Effective Shields Exclude EMP .....	48
Figure 17. Effective Equipment Hardening .....	54
Figure 18. Grounding Topology .....	55
Figure 19. EMP Hardening Cost Considerations .....	62

## ACKNOWLEDGEMENTS

The author takes this opportunity to thank the following people for their support in helping to make this thesis the quality product that it is:

1. Mr. Dean Harrell, Mr. Robert Schoffstall, Mr. Rich Engle, Professor X. K. Maruyama, and Professor O. Heinz, for providing me with reference materials that proved to be extremely helpful in putting this project together and in heading me in the right direction.
2. Professor K. E. Woehler for proof reading the second chapter and setting straight technical errors that I had made in describing the electromagnetic pulse and its various environments.
3. Professor D. C. Boger, Thesis Advisor, and D. E. Summers, LtCol USMC, Second Reader, for their time, advice, and support in delivering this thesis.

Last, but by no means least, I wish to publicly thank my wife, Rosemary, and my daughter, Michelle, for their love, help, encouragement, and patience throughout this entire experience.

## I. INTRODUCTION

### A. BACKGROUND

On August 6, 1945, the world was thrust into the atomic age with the detonation of the first atomic bomb over the Japanese city of Hiroshima. While the bomb's designers were relatively certain of the effect that it would have in terms of blast, heat and radiation, they were less certain of the effect it would have in terms of an electromagnetic pulse (EMP). Although the weapon's designers predicted that an EMP would be created at the moment of detonation, no effort was made to record the EMP's effects or the damage that it may have caused to the electrical equipment and electronic components within Hiroshima. Therefore, the scientists did not have any proof as to the existence of the suspected electromagnetic pulse.

It was a peaceful July evening in 1962 on the Hawaiian Island of Oahu. Suddenly, on the horizon there was a greenish white flash and the sky was described as turning pink, then orange, then red, and the heavens were filled with a ghastly light. Unknown to the islanders, at precisely that time, the United States had detonated an atomic device 248 miles above the small Pacific atoll known as Johnston Island, 800 miles southwest of Hawaii. Approximately one second after the

blast, the Hawaiian Islands began to experience severe problems with electronic failures. Burglar alarms started to ring, street lights blacked out, fuses blew, circuit breakers tripped, and power lines went dead. Finally, almost seventeen years after the detonation over Hiroshima, scientists had the evidence they needed to prove the existence of the electromagnetic pulse. [Ref. 1: p. 41]

Unfortunately for science, the "Limited Test Ban Treaty" of 1963, which prohibited the above ground testing of nuclear weapons, served to eliminate the possibility for further high altitude nuclear burst EMP testing. All future EMP information would be compiled through the use of subsurface nuclear tests, analysis of existing atmospheric test data, theoretical calculations, and non-nuclear simulations. [Ref. 2: p. 139]

## **B. PURPOSE**

The intended purpose of this thesis is to develop a document which may be used by nontechnical communications personnel in their effort to gain an insight and understanding of the phenomena called electromagnetic pulse (EMP). Further, the reader will discover how EMP can effect electronic components and electrical and communications equipment. This thesis will provide the communicator with information that can be used in the development of a plan to minimize the harmful effects of EMP.

Specific areas of discussion include the generation of EMP, the various types of EMP and their effects on communications equipment, and how to reduce the harmful effects that EMP may cause to unprotected communications and electronic equipment. The scope of this thesis is intentionally broad and specifically nontechnical in nature in an effort to offer a general introduction to the important issues pertaining to EMP. It is written for consumption by those who may be involved in communications systems operation, safety and security but who do not have an engineering background.

### C. THESIS OUTLINE

This thesis is designed to provide the reader with no previous knowledge concerning the electromagnetic pulse (EMP) a general discussion of what the EMP is and how it effects electronic and communications equipment. Chapter II will discuss how an EMP is generated and the various EMP environments. Chapter III discusses EMP coupling and EMP effects on electronic equipment and cables. It also describes the concept of radio blackout. Chapter IV defines EMP hardening and presents ways to reduce the EMP environment and raise system threshold. The chapter then discusses factors to consider when selecting a hardening approach and system testing. Chapter V presents an approach to estimating EMP hardening costs for both tactical and stationary systems. It

then describes life cycle cost considerations, the benefits of EMP hardening and discusses two cost/benefit analysis models. The thesis concludes with Chapter VI which presents the summary and conclusions.

## II. THE ELECTROMAGNETIC PULSE

### A. INTRODUCTION

The detonation of a nuclear device is usually thought to produce three destructive environments: blast, thermal radiation and nuclear radiation. As illustrated in Figure 1, at least one additional destructive environment is also produced [Ref. 3: p. 3]. The fourth environment does not destroy people, equipment, and buildings with devastating shock waves, searing heat, or deadly radiation; rather, it causes damage or destruction through the sudden release of a high intensity burst of energy in the radio and microwave frequency spectrum. This sudden burst of energy is called the electromagnetic pulse (EMP). Because the EMP is received in an extremely short period of time, intense currents are produced which are known to degrade or damage the sensitive circuits and components within electronic and electrical equipment and communications systems.

### B. EMP GENERATION

The generation of an electromagnetic pulse is actually a two-step process which begins with the detonation of a nuclear device. The first step is the creation of a sudden burst of high-energy photons which are produced by the nuclear explosion. These high-energy photons consist of prompt gamma

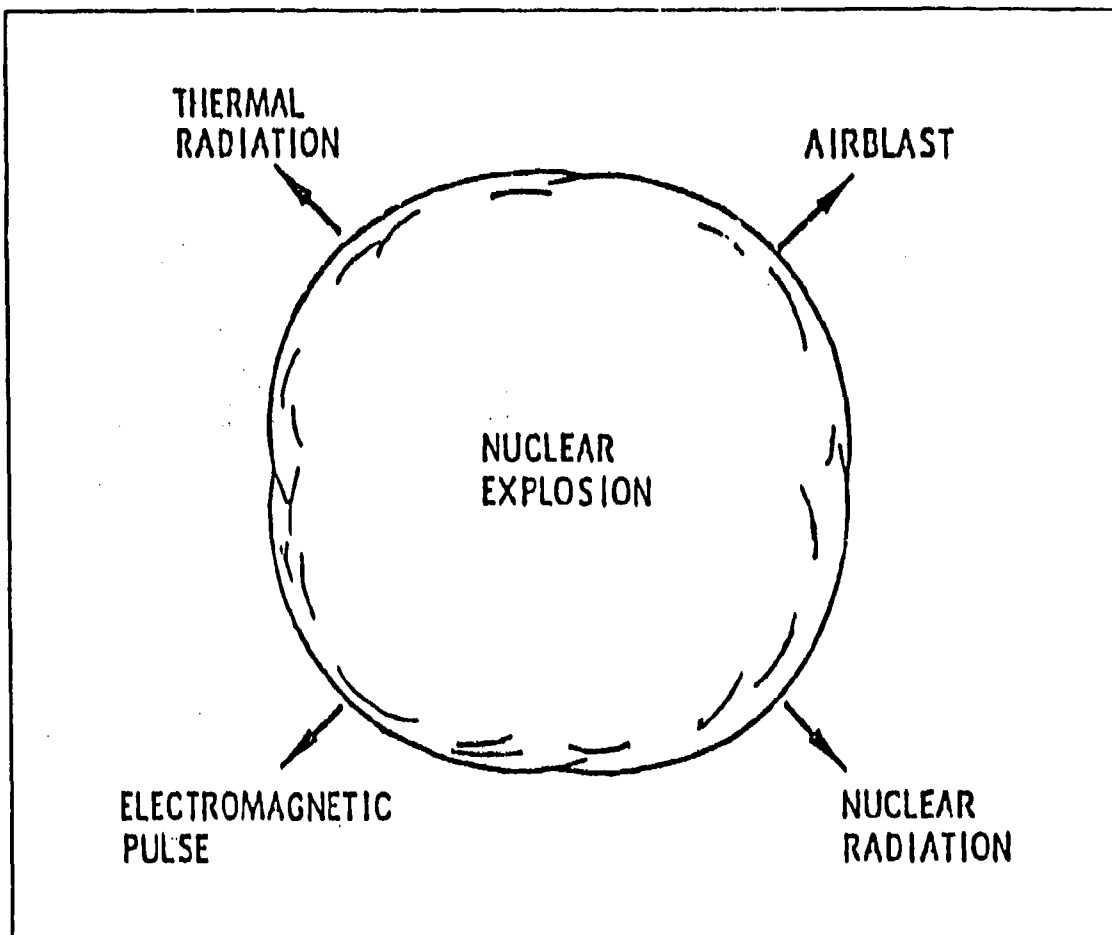

Figure 1. Nuclear Detonation Environments

rays and x-rays. Prompt gamma rays are produced during fission, when the nucleus of an atom splits into nuclei of lighter atoms and is accompanied by the release of energy, and by neutron interactions with the nuclear device's materials. The prompt gamma rays are so named because they have an extremely short rise time, about ten nanoseconds from detonation, and a very short duration, less than 0.1 microseconds. For reference, ten nanoseconds equals ten billionths of one second, and 0.1 microseconds equals one ten



millionth of one second. X-rays are emitted somewhat later and are of lower energy but are about 1000 times more numerous than the prompt gamma rays.

The second step in the generation of an EMP is the production of moving charged particles. As seen in Figure 2, when the charged particles are generated in the atmosphere, the dominant production process results from Compton scattering of the prompt gamma rays [Ref. 4: p. 5]. This occurs when the gamma rays collide with electrons present in the air molecules. The collisions release a low energy secondary photon and an electron, and leave behind a positive ion. The free electron has almost the same direction and speed as the original gamma ray and is referred to as a Compton electron after the discoverer of this effect, Arthur H. Compton.

The negatively charged electrons produced by the Compton scattering move away from the center of the burst at a much faster rate than do the positively charged ions. The initial result is a separation of charges with the region closer to the center of the burst having a net positive charge and the region farther away having a net negative charge. This separation of charges produces an electric field. The fast moving Compton electrons represent an electric current. In addition, the high energy Compton electrons produce secondary electrons in the atmosphere. These secondary electrons together with the Compton electrons and the electric field

produced by the charge separation of the electrons and ions act like an antenna system that launches a propagating electromagnetic wave of high intensity. This effect constitutes the electromagnetic pulse (EMP). [Ref. 5: p. 515]

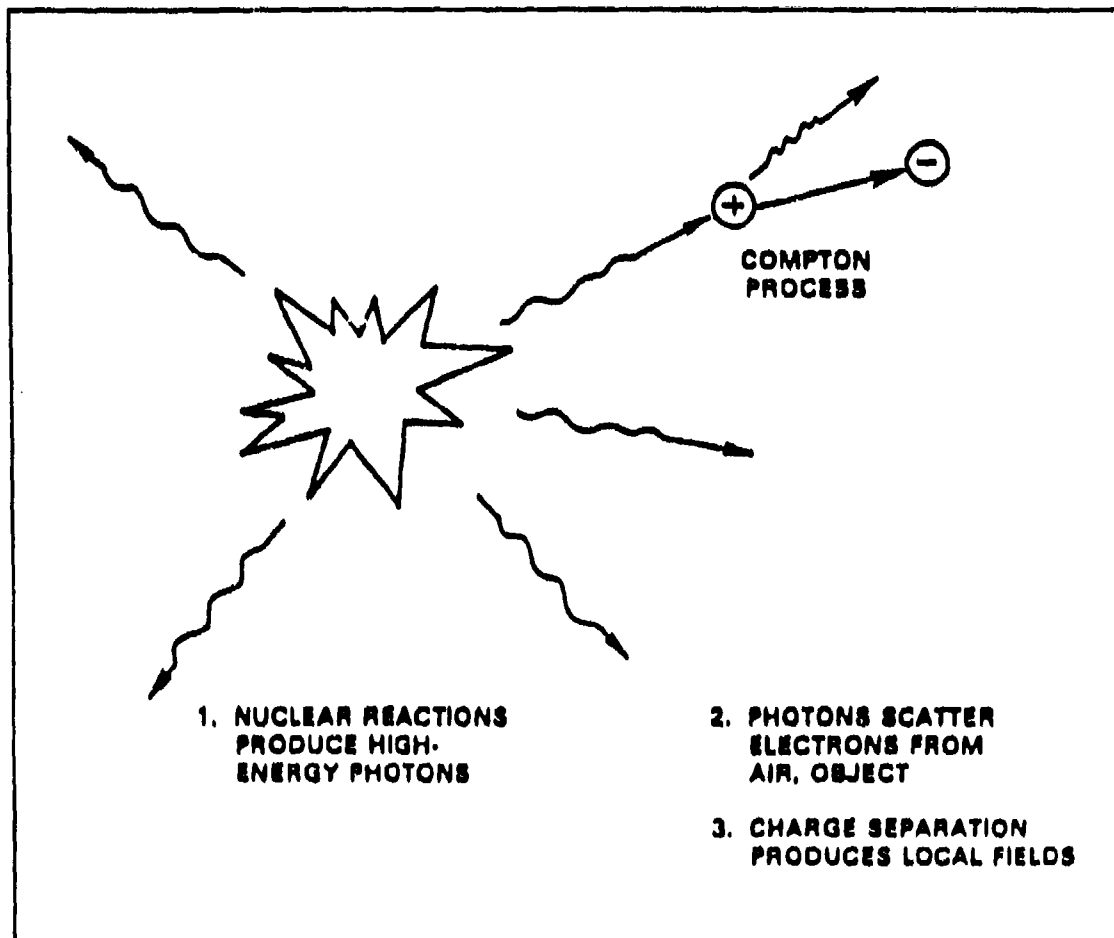

Figure 2. Creation of an Electromagnetic Pulse

### C. EMP ENVIRONMENTS

Figure 3 shows the four possible scenarios for the detonation of a nuclear device which lead to the creation of an EMP environment [Ref. 6: p. 19]. The first environment is

generated by a nuclear burst below the earth's surface. The second environment results from a surface burst, and includes detonations up to a height of approximately two kilometers (km). An air burst in the near atmosphere, roughly between two and 20 km produces the third EMP environment; and a high altitude burst in the earth's upper atmosphere, generally defined as above 30 km, results in the fourth environment. [Ref. 6: pp. 20-32] The various EMP environments will now be discussed.

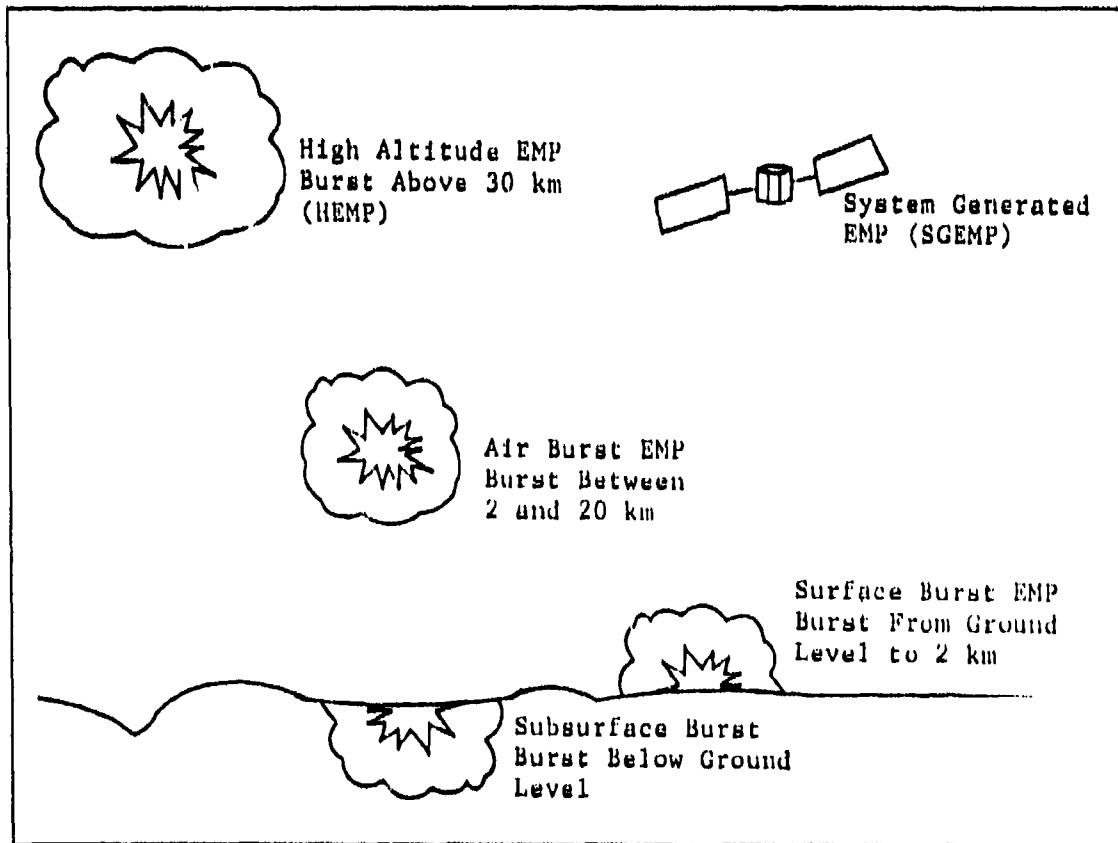

Figure 3. EMP Environments

## 1. Subsurface Burst EMP

As with all nuclear bursts, an EMP results from subsurface and underwater detonations. However, in both of these cases, due to the density of the surrounding material the prompt gamma rays produced by the blast do not propagate very far, and the Compton electrons distribute their energy very rapidly. This leads to an absence of the extensive strong current systems that produce an EMP. As a result, the EMP is very weak and equipment that is close enough to be impacted by the detonation is destroyed or damaged by the weapon's shocking blast and searing heat, and EMP is not a consideration. [Ref. 5: p. 61]

## 2. Surface Burst EMP

Surface burst EMP is produced through the detonation of a nuclear device on or within 2 km of the earth's surface. It is created when the prompt gamma rays which are released by the nuclear explosion and the atoms within the earth's atmosphere collide to produce a current flow of scattered electrons. The negatively charged electrons move outward from the center of the detonation and leave the positively charged ions behind. The free electron flow stimulates the surrounding area to produce a strong electric field. The ground is a relatively good conductor of electricity and it provides a path through which the electrons return to the burst point. This flow of electric current generates a strong

magnetic field in the area of the detonation. [Ref. 5: pp. 517-518] Both fields are characterized by a short rise time to peak strength, on the order of a few nanoseconds, and the electric field peaks at about 100,000 volts per meter (100 kV/m) but may reach values approaching 1,000 kV/m. [Ref. 4: p. 28] Figure 4 illustrates that the damaging effects of the explosion can directly impact an area from 3 to 5 km from ground zero depending on the yield of the weapon and its height above the surface at the time of detonation. This area is referred to as the "source region." [Ref. 6: p. 31]

A "radiated region" may extend beyond 10 km. The atmospheric asymmetry which is present between the air and the earth results in the creation of a vertical electric field within this area. In the radiated region the EMP may be significant, but its impact rapidly diminishes with increasing distance from the burst site. [Ref. 4: p.32]

Most of the energy for surface burst EMP is centered below 1,000,000 Hz (1 MHz) in the radiofrequency spectrum. Electronic and communications equipment within the source region will be subject to damage and possible destruction from the nuclear device's blast, heat, and radiation effects as well as those of the EMP. Equipment in the radiated region will be impacted more by the influence of EMP and less by the device's more physically damaging effects. [Ref. 6: p. 30] Communicators should note that the vertically oriented electric field present in the radiated region will have a

stronger influence on vertical structures such as communications antennas.

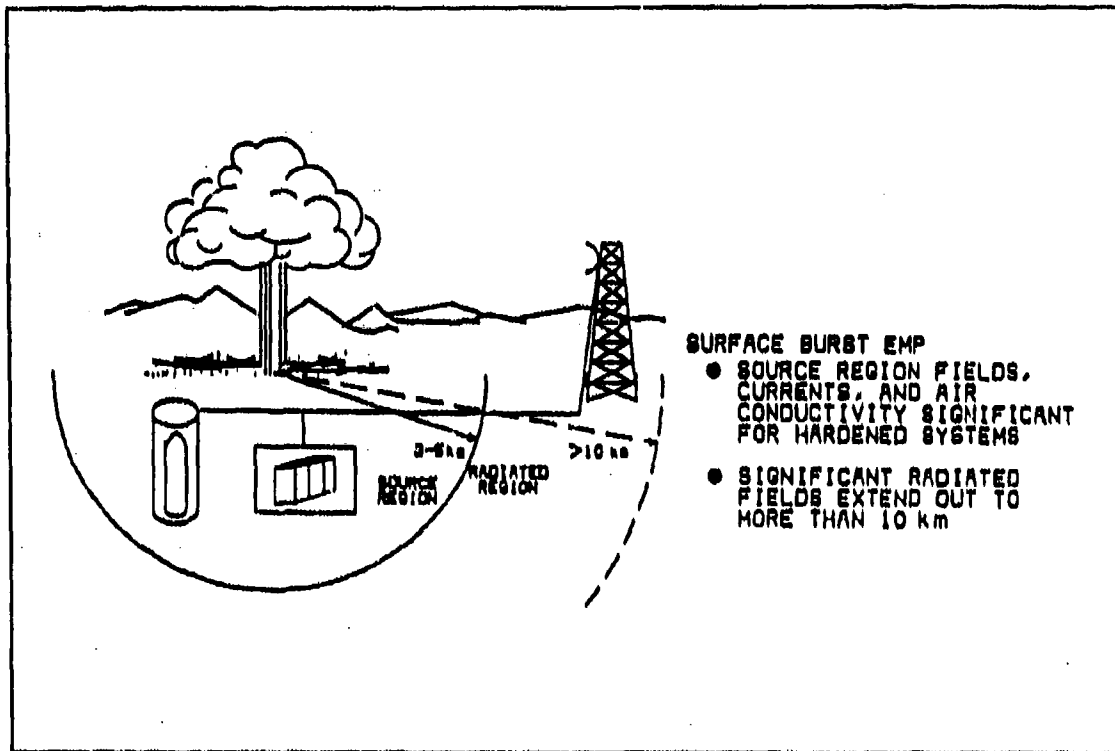

Figure 4. Surface Burst EMP

### 3. Air Burst EMP

Air burst EMP is produced by nuclear detonations at altitudes of between 2 and 20 km above the earth's surface. The source region is similar to that of the surface burst, and the region's size will depend on weapon yield and height of burst. Within the source region, prompt gamma rays produced by the explosion collide with atoms in the air to generate a current flow of scattered electrons. Positive ions remain behind at the burst site as the negative electrons move away from the burst. This separation of ions and electrons

produces an electric field. Unlike the surface burst, there is not a return path for the electrons to follow through the ground, and a magnetic field is not generated.

In the radiated region, the existence of asymmetry in the atmosphere may work to propagate the electric field which has been created by the blast. This results when asymmetries in the atmospheric density gradients permit the ions and electrons to become further separated through the different atmospheric layers, and a vertical electric dipole radiation field is produced. Further atmospheric asymmetry results from water vapor densities which vary with season and height. Although these asymmetries may combine, the peak electric field strength in this region is only about 300 volts per meter (v/m) at a distance of approximately 5 km from the center of the burst. Rise time to peak electric field strength averages between 1 and 5 microseconds. [Ref. 4: pp. 38-43]

Electronic and communications equipment located within the source region of an air burst, generally airborne systems, will be subjected to strong EMP as well as shock, heat, and radiation. In the radiated region, equipment will encounter a weaker EMP which will decrease with increasing distance from the center of the blast. As with the surface burst, the vertical orientation of the electric field makes vertical structures such as antenna towers particularly susceptible to the harmful effects of the EMP.

#### 4. High Altitude Burst EMP

A nuclear burst which occurs in the presence of very little atmosphere, above 30 km, is considered a high altitude detonation. The EMP produced on the earth's surface and in the atmosphere is referred to as high altitude EMP (HEMP).

As the prompt gamma rays travel in a downward direction from the center of the detonation, they encounter an increasing number of atoms within the atmosphere. The gamma rays interact with the atoms to produce the Compton electrons previously discussed. The free electrons hurtling toward the surface are deflected by the earth's magnetic field and are forced into a turning motion about the earth's magnetic field lines. This turning motion of electrons results in a significant and widely distributed current which is horizontal to the earth's surface. This current acts like a large area antenna that radiates in the direction of the earth's surface. Because the HEMP rises to its peak electric field strength in a few nanoseconds and then decreases in a few tens of nanoseconds, the frequency spectrum reaches from hundreds of MHz to kHz. The value of the electric field strength received on the earth's surface is on the order of 10 kV/m to 50 kV/m.

What makes high altitude burst EMP a greater threat than other EMP environments is the fact that while the radiated electric field strength of the surface burst drops off rapidly with distance, the strength of the high altitude burst remains relatively constant throughout the source



region. This significantly increases the area of influence of the source region and the area in which electrical and communications equipment may be damaged or destroyed by the HEMP. As shown in Figure 5, because the HEMP travels at the speed of light, a single detonation at a height of 500 km above northeastern Kansas could affect the entire continental United States almost simultaneously [Ref. 4: p. 9].

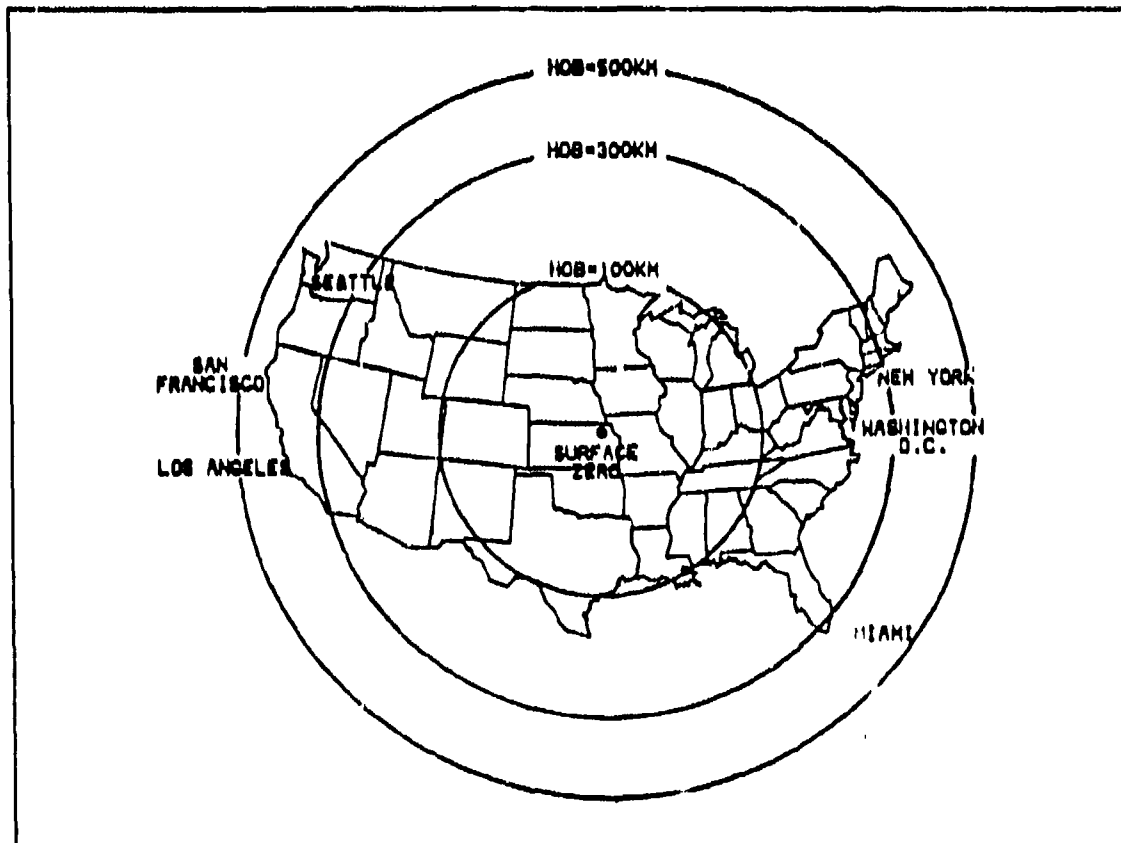

Figure 5. High Altitude EMP Ground Coverage

Although unprotected electrical equipment and electronic components may be effected by the HEMP, if the blast occurred during daylight, people on the ground would probably not know that a nuclear device had been detonated.

As shown in Figure 6, the source region which this type of burst generates is circular in nature and roughly 80 km thick at the center. It tapers off to approximately 40 km at the edges of the region. The source region may extend for great distances depending on the height of the burst and the magnitude of the weapon. It will generally extend horizontally to points tangent to the earth's surface at the horizon [Ref. 5: pp. 518-520].

HEMP is the threat most commonly specified when designing systems for EMP protection. The communicator must be aware of the impact which this type of EMP may have on the communications system, electrical equipment, and electronic components. Chapter IV discusses the defensive measures that can be taken to minimize the harmful effects of HEMP.

#### **5. Magnetohydrodynamic EMP**

Magnetohydrodynamic EMP (MHD-EMP) is really a product of the high altitude nuclear burst; however, it is discussed separately due to its characteristics and the effects which it has on electronic and communications equipment that are different from HEMP. The name is a result of the processes that make up this particular form of EMP. Through magnetohydrodynamic processes, the explosion of a nuclear weapon produces slow variations in the earth's geomagnetic field. These variations induce circling currents which result in electric fields. Relatively speaking, MHD-EMP occurs much

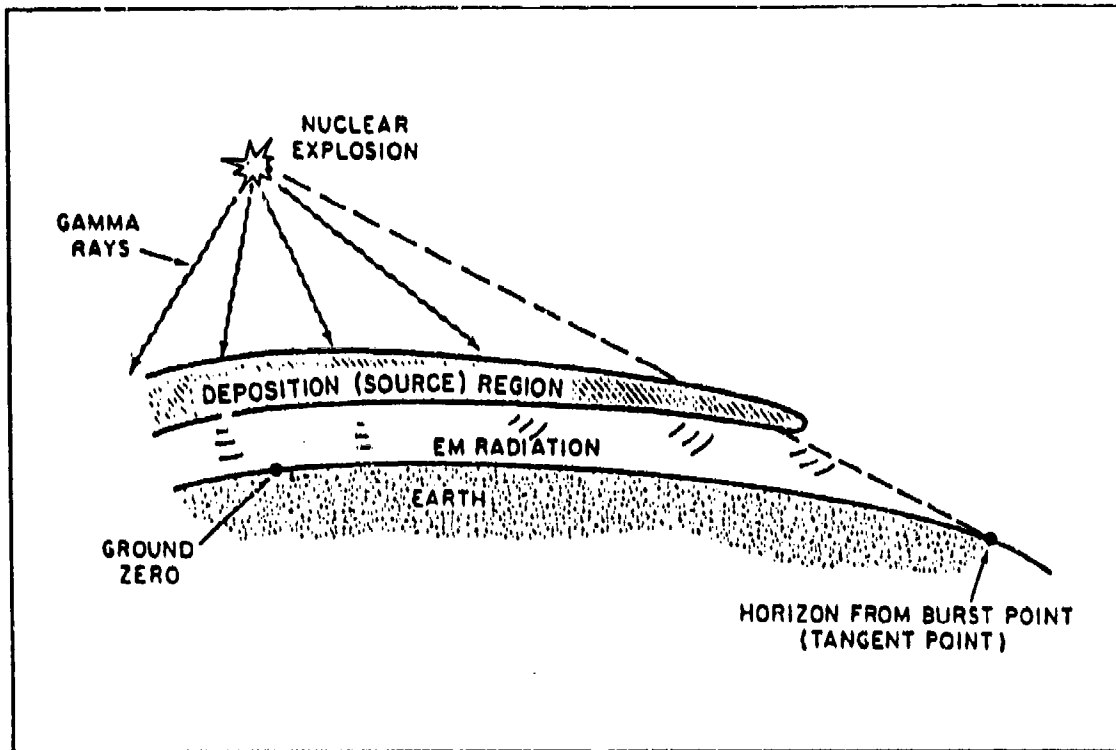

Figure 6. HEMP Source Region

later than HEMP. It arrives in two phases which are referred to as the "early phase," from 1 to 10 seconds after the detonation, and the "late phase," from 10 to 1000 seconds.

The MHD-EMP fields are characterized by very low frequency, low peak amplitudes on the order of 3 to 30 volts per kilometer, and very large areas of coverage in the range of several hundred kilometers. All MHD-EMP characteristics will vary depending on weapon yield and burst height. The communicator should be aware of MHD-EMP because its electric fields pose a threat to very long land lines such as telephone lines, extremely low frequency (ELF) networks, and power distribution systems. [Ref. 4: pp. 20-24]

## **6. Transient Radiation Effects In Electronics**

Transient radiation effects in electronics (TREE) are not an EMP and are not considered in the HEMP environment. However, it is included in this section because TREE damage can occur in conjunction with EMP and system generated EMP (SGEMP), which will be discussed in the next section, if the electrical equipment and electronic components are located in the vicinity of an air or surface detonated nuclear explosion. If the prompt gamma rays produced by the nuclear explosion interact directly with components of electrical systems, the resulting damage mechanisms are called TREE, and the dominant process is the production of the moving charged particles which are referred to as the photoelectric effect. This occurs when the prompt gamma rays collide directly with the atoms in the electronic components. This differs from Compton scattering in that although a negative electron is released and a positive ion is left behind, the released electron does not have the strong forward direction as in the Compton collision. Rather, the electron energy is rapidly transferred to other electrons in the material which leads to damage of the sensitive electronic components within the system. [Ref. 7: p. 2-16]

## **7. System Generated EMP**

System generated EMP (SGEMP) differs from other forms of EMP in that it interacts directly with electronic and

communications systems. The various forms of EMP previously discussed produce their radiated electric fields through gamma rays colliding with atoms present in the earth's atmosphere. These collisions produce the familiar Compton electrons or photoelectric effect which result in an electric field. The SGEMP's electric field is produced when the gamma rays and x-rays collide directly with the system itself. Obviously, SGEMP is associated with high altitude nuclear bursts where the gamma rays and x-rays can interact with the system before they are absorbed by the atmosphere. Systems in low earth orbit and close proximity to the weapon at the time of detonation would be subjected to all of the device's damaging effects, and the system would only be affected by SGEMP if it were hardened to withstand the explosion. [Ref. 6: pp. 34-37]

Where the effects of SGEMP are of particular importance is for those systems outside of the earth's atmosphere such as satellites and reentry vehicles. The electronic components and shielding of these systems release electrons when struck by the gamma rays and x-rays. These electrons, once freed, continue to travel through the system where they interact with the internal electronics to cause damage or destruction through induced electric currents. In the near vacuum of space, the electric fields can achieve values on the scale of 100,000 to one million volts per meter. [Ref 6: pp. 521-522]

Communicators using space-based satellites for communications links and/or retransmission must be aware of the damage which SGEMP can cause to those systems. Plans should be developed to use alternate communications routes if the threat of a high altitude nuclear burst exists. High frequency (HF) radio links and airborne retransmission are possible alternatives if communications satellites are damaged or destroyed.

#### D. SUMMARY

This chapter has attempted to provide the reader with a basic understanding of what the electromagnetic pulse is, how it is generated, and the various types of environments in which the EMP may be found. The next chapter will describe the harmful effects which the EMP can have on the sensitive circuits and components found in electronic and electrical equipment and communications systems.

### III. ELECTROMAGNETIC PULSE EFFECTS

#### A. INTRODUCTION

The focus of Chapter II is to aid the reader in identifying the causes of the electromagnetic pulse (EMP) and to familiarize him/her with the environments in which the EMP will be found. This chapter will discuss how the EMP enters the equipment and what effects it has on the communications system and the electrical equipment and electronic components that make up the system. The emphasis of this chapter is on the effects that a high altitude electromagnetic pulse (HEMP) can have on the electrical components and communications equipment. The reader is reminded that HEMP is the EMP environment that presents the greatest threat to the communications system.

Recall from Chapter II that HEMP results in the production of radiated electromagnetic fields. These fields reach amplitudes on the order of tens of thousands of volts per meter and induce transient currents and voltages into the sensitive electronic components found in electrical and communications equipment. Transient currents and voltages are those which have a very short duration and pass away very quickly. The process by which these transients are induced

into the equipment is referred to as coupling and will be discussed in the following section. [Ref 6: p. 46]

## B. COUPLING

Coupling occurs when electromagnetic energy enters an electrical system where it can cause damage or destruction to the sensitive electronic components. Coupling is accomplished by one of two processes: either the radiated EMP impinges directly on a system, or the current and voltage pulses induced by the EMP collect on external conductors and are then transferred into the system. [Ref 8: p. 10-16] Any energy collector which allows electrical current to flow through it is called a conductor. Antennas may be deliberate or nondeliberate energy collectors. An antenna designed to transmit and/or receive radio frequencies is an example of a deliberate collector. The following is a list of the more common nondeliberate antennas which can also function as conductors:

- Long cables, pipes, and conduits;
- Antenna leads, guy wires, and support towers;
- Power lines and telephone cables;
- Electrical wire and conduit within buildings;
- Wire fences and expanded metal lath;
- Railroad tracks, aircraft bodies, and ships; and,
- Grounding systems and metal buildings.



The amount of energy collected will depend not only on the size and shape of the collector, but also on the orientation of the collector with respect to the source of the EMP. [Ref 5: pp. 520-521] As shown in Figure 7, all conductors act like antennas which first collect the EMP and then deliver it to the system [Ref. 6: p. 49]. Long conductors such as power lines are particularly susceptible to the low frequency components of the HEMP. For example, an EMP could provide enough energy to a wire the length of a football field to light 1,500, 100 watt bulbs, for an instant [Ref. 1: p. 42]. Short conductors are more susceptible to the HEMP's high frequency components. [Ref 9: p. 3]

It is important to note that equipment does not have to be physically connected to a conductor for damage to occur. The energy from the HEMP may be coupled to the equipment through a process called induction. This is the production of electrification in a component or circuit through its mere proximity to the energy source. For example, electrical equipment placed next to one or more of the above listed deliberate and nondeliberate antennas during a HEMP could experience damage. However, and as illustrated in Figure 8, the usual manner in which energy is coupled into a system is through one or more of the following: diffusion, leakage, apertures, and penetrations. [Ref. 6: p. 53]

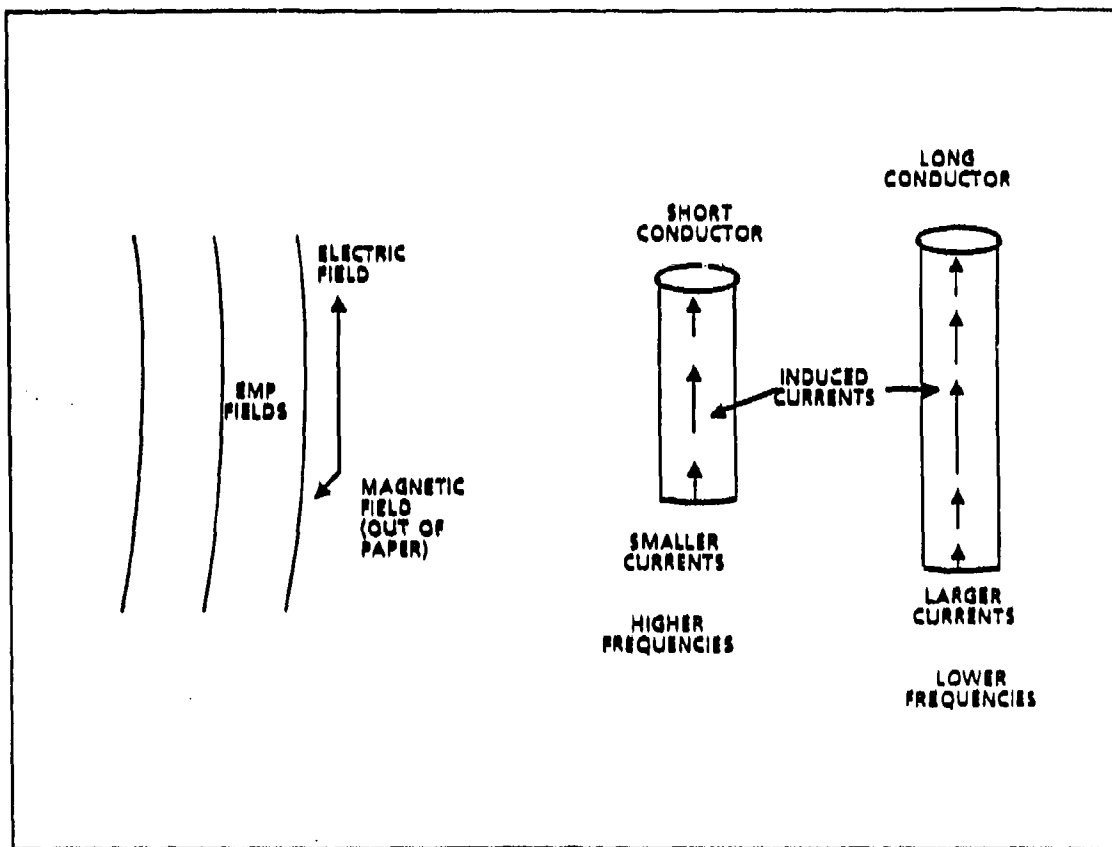

**Figure 7. All Conductors Act Like Antennas**

### 1. Diffusion

Diffusion occurs when the current passes directly through the equipment's housing or case. This coupling path will tend to be insignificant if the housing is a good conductor of electrical current such as a metal radio shelter. If the housing is not a good conductor or is some type of composite material like fiberglass or plastic, then the diffusion of energy into the equipment may be significant.

## **2. Leakage**

Leakage of energy into equipment usually occurs around joints, seams, and welds in the equipment's housing. The magnitude of the leakage will depend on the electrical conductivity across the various points of leakage in the equipment case.

## **3. Apertures**

Apertures are openings in the housing such as doors, windows, and vents through which the current enters the equipment. The degree of coupling from this type of entry will depend on the size of the aperture and its location on the housing.

## **4. Penetrations**

Penetrations in the equipment housing for items such as cable entries, antennas, and access connectors for ancillary equipment provide another entry point through which coupling can occur. As with apertures, the amount of coupling from penetrations will depend on their size and location on the housing. Penetrations and apertures that face the source of the EMP normally experience greater coupling effects than those facing away from the EMP source.

## **5. Coupling To Aircraft**

Coupling in aircraft is important to the communicator. Aircraft are frequently required to support ground units and require the establishment and maintenance of communication

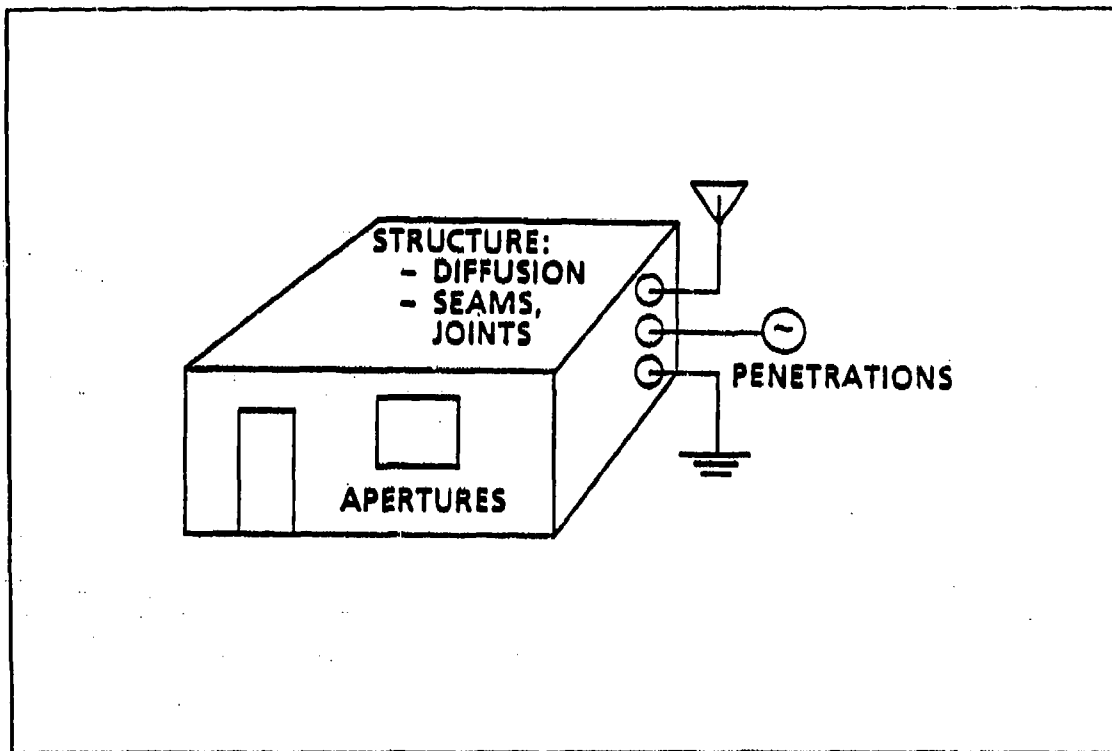

**Figure 8. EMP Coupling to Systems**

links to accomplish this mission. Also, aircraft may be used for the aerial retransmission of long distance communications in areas where other communications means are unavailable or impractical.

At the moment of a HEMP, aircraft traveling in free space would be engulfed by the EMP propagating in the free space environment. The energy pulses striking the plane would be partially reflected and scattered. This effect would result in an electromagnetic field being developed on the surface of the aircraft. The metal skin of the aircraft would act like a conductor to reduce the effect of diffusion through the skin of the plane; however, Figure 9 identifies a few of

the apertures, leakage areas, and penetrations in the aircraft's fuselage that would permit some of the energy from the surface electromagnetic field to couple with the plane's sensitive interior components [Ref. 6: p. 55]. The communicator should assume that aircraft communication assets will be lost in a HEMP environment and plan for alternate means of communications. [Ref 10: pp. 225-227]

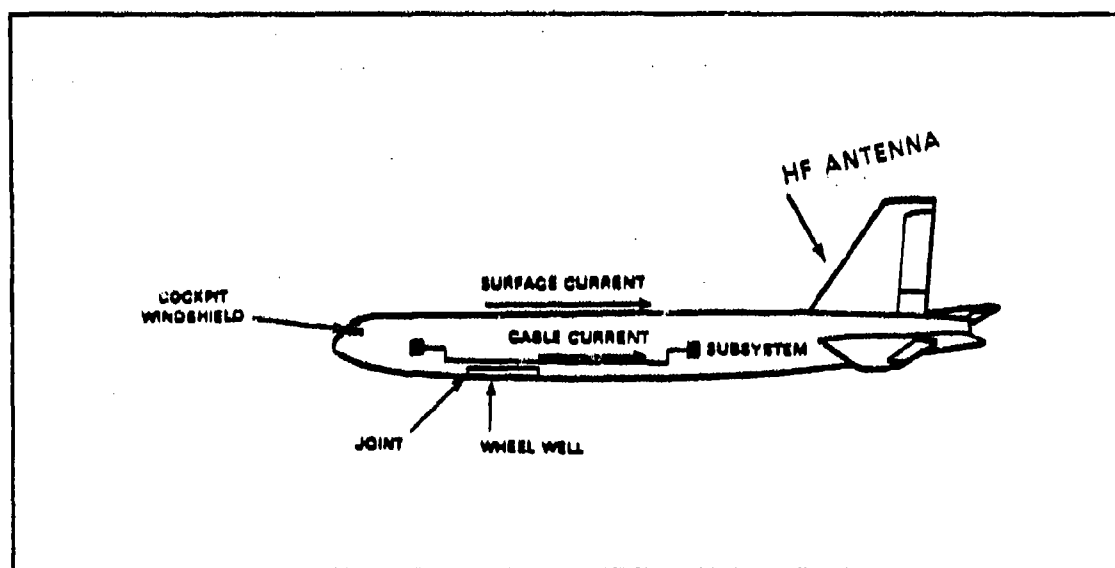

Figure 9. EMP Coupling to Aircraft

## 6. Coupling To Ships

Coupling in ships is important to the communicator because the navy frequently transports ground units to the objective area and supports their movement ashore during amphibious operations. Further, the navy supports operations ashore both logistically and with naval gunfire. All of these efforts require numerous communications links between ship and shore. The loss of these vital communications networks due to

the harmful effects of EMP could prove disastrous to the units ashore when they are deprived of the necessary support.

Figure 10 shows how some of the EMP's radiated electromagnetic fields can penetrate surface ships directly through apertures in the ship's structure such as hatches and ports [Ref. 6: p. 59]. Additionally, coupling can occur through penetrations in the ship's hull for antennas, cables, conduits, and other devices. Because a ship is constructed in sections, numerous seams, welds, rivets, and bolts are present which would permit coupling through leakage. Finally, because the skin of the ship is metal and a good conductor, coupling from diffusion would be minimal. [Ref 11: p. 4]

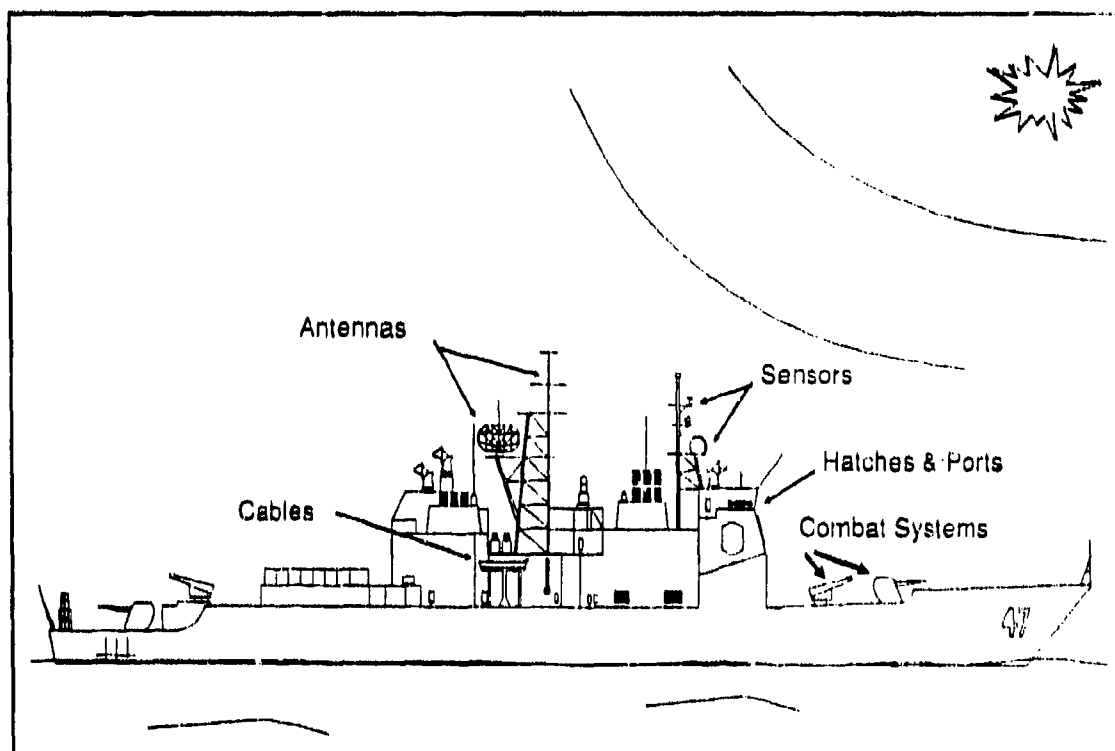

Figure 10. EMP Coupling to Ships

The communicator, who plans to utilize shipboard communications assets in a post-HEMP environment, will probably be disappointed at the results achieved if a serious effort is not made to protect those assets.

#### 7. Coupling To Ground-Based Systems

Due to the various types of equipment employed in the ground-based system and the numerous types of equipment shelters used, the impact that coupling will have on the system will depend on the impact it has on the specific pieces of equipment. Significant diffusion is likely to occur in all equipment which is not housed in a metal container. This will include radio and test equipment which has a plastic case and other equipment housed in non-conducting material. Equipment containers and radio cases made of thin metal can be very effective in preventing coupling through diffusion. The drawback is that the container must be continuous and without openings. This makes operation of the equipment virtually impossible. [Ref. 12: p. 1-28]

Antennas designed to receive below 100,000,000 Hz (100 MHz) are especially good collectors of EMP. The military very high frequency (VHF) band operates in the range of 30 to 79.95 MHz, so essentially all portable radios will receive direct EMP penetration through their integral antennas. A major part of the ground-based system can be made up of vehicles as displayed in Figure 11 [Ref. 6: p. 61]. Vehicles, which are

themselves conductors and that have power and antenna cables running across their bodies, will either directly or indirectly induce currents into those cables. The EMP currents created on a vehicle body or on cable insulation can induce currents in adjacent conductors. This means that even shielded cables can have transients induced on their inner cores. [Ref 13: pp. 37-40] In fact, all of the equipment utilized within the ground-based system will have apertures, penetrations, and seams which can permit coupled energy to interact with internal circuitry. Cabling, antenna leads, and the power distribution system are only a few of the items which will act like large effective antennas to collect EMP currents and deliver them to the equipment. [Ref 6: pp. 39-84]

Communicators must consider all electric equipment and electronic components when they consider the effects of the EMP on the system. Power generators, vehicles, computers, and heating, ventilation and air conditioning systems are only a few of the numerous pieces of equipment which make up the total system and whose loss could degrade or destroy the system's ability to perform its mission.

### C. EMP EFFECTS ON ELECTRONIC EQUIPMENT

Threat level EMP has about one joule per meter squared of energy; however, about one millionth of this energy level, approximately one microjoule, delivered to a single junction on an active solid state component may be sufficient to burn



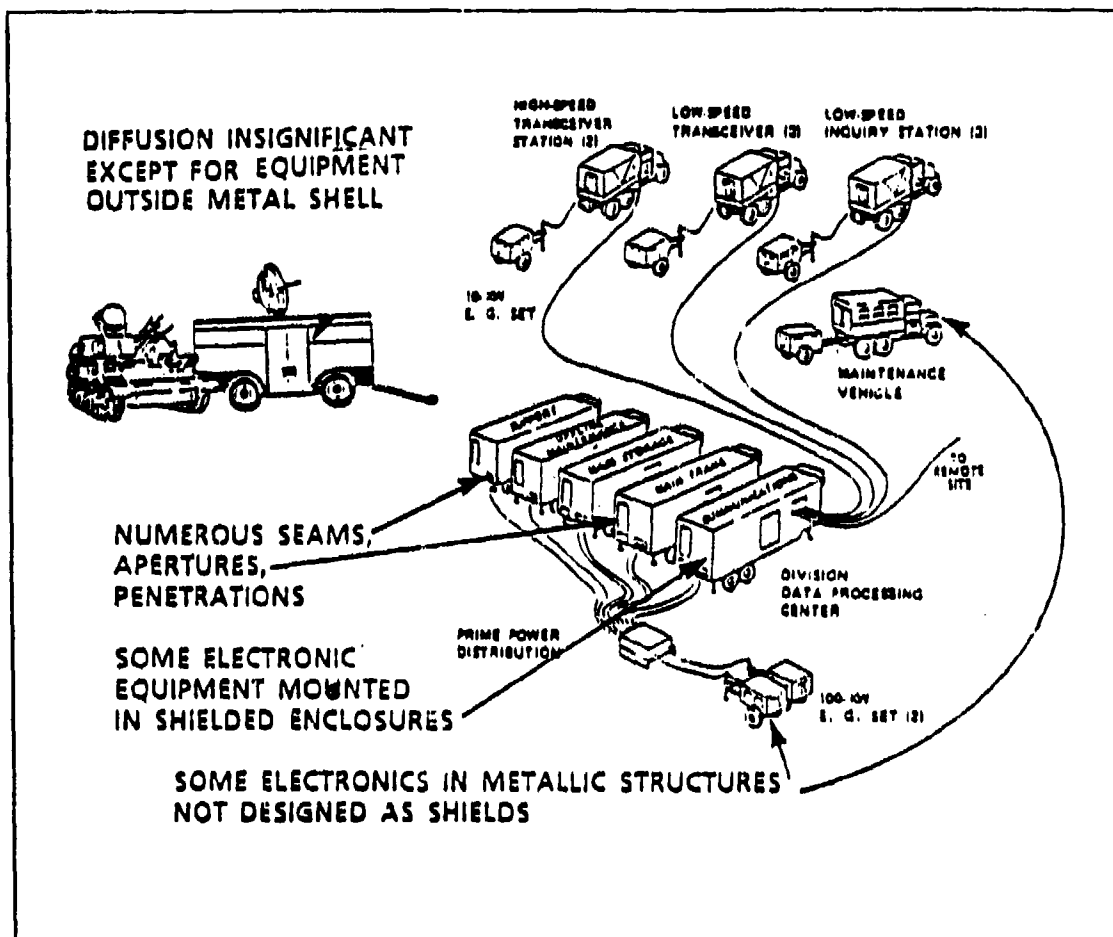

**Figure 11. EMP Coupling to Ground Vehicles**

it out. [Ref. 14: p. 308] The previous section discussed how the EMP's energy transients are collected and delivered into the system. This section will discuss the harmful effects which those transients can cause to unprotected equipment.

Technological advances in electronic circuitry have led to a trend in the development of new electronics toward placing more components into smaller spaces. As a result of this trend, circuits have become more susceptible to EMP effects. This high density packing of components reduces the circuit's

ability to conduct away the heat which results from the EMP's intense voltages and current flows. [Ref. 15: p. 23] The unwanted energy transients and resultant heat that interact with the sensitive components generally results in either damage or upset to the equipment. Figure 12 illustrates the results of EMP interaction with systems [Ref. 6: p. 47].

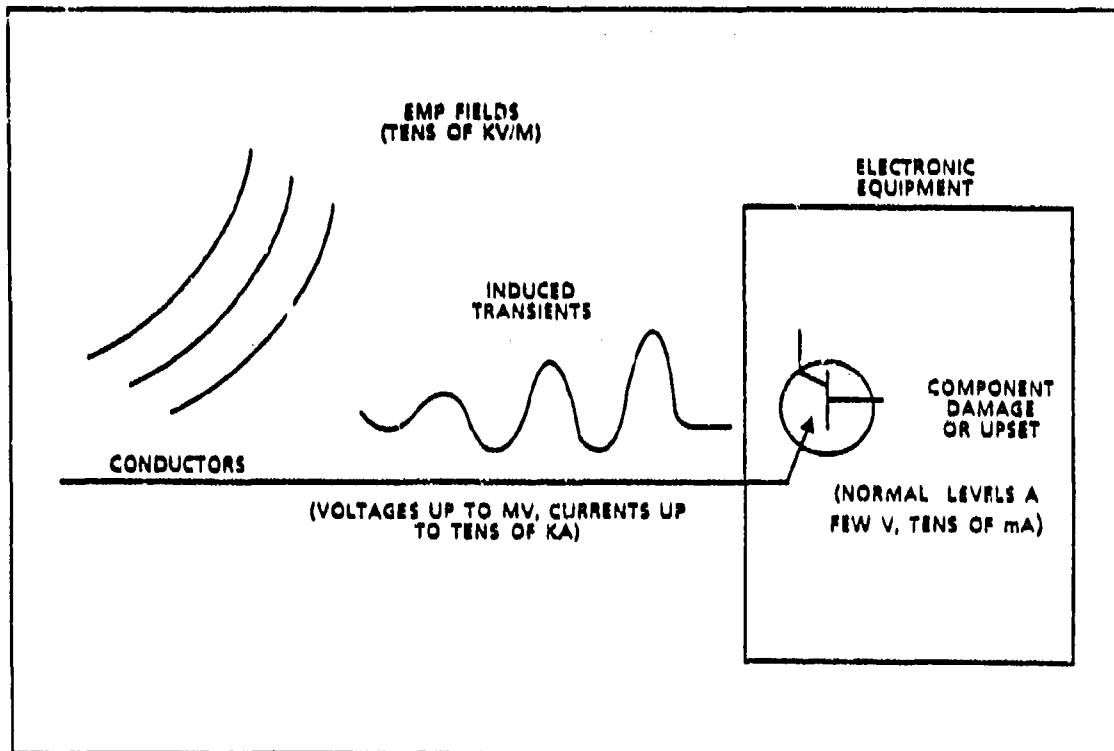

Figure 12. Results of EMP Interaction with Systems

### 1. Component Damage

Component damage that results from an EMP may be easily defined as any component which fails to perform its intended operation and must be replaced as a direct result of the EMP. Refer to Figure 13 for an illustration of the effects that the EMP has on electronics [Ref. 6: p. 65]. As

the transient energy is collected and passed to the component, the energy encounters resistance within the component. Semiconductors can be expected to receive the most damage because they are not good conductors, and this characteristic results in strong resistance which will convert the electrical energy into heat. It is the resultant heat that causes the component to fail. In the presence of increased heat, silicon, which is the primary element in semiconductors, actually loses its resistance capabilities. This results in local melting as the higher currents produced by the EMP flow across the semiconductor. As the currents increase, greater heat is generated and the resistance decreases. Also, semiconductors are sensitive to very small currents which makes them particularly susceptible to damage from the large currents present with an EMP. [Ref. 6: p. 64]

Damage will generally occur where the energy collector enters the equipment, for example, at the antenna tuner, power supply, or radio/wire interface [Ref. 9: p. 4]. Active, rather than passive components, are more susceptible to EMP damage. Semiconductors are more susceptible than vacuum tubes or electromechanical devices. Semiconductors will almost always experience damage rather than upset due to the relatively short duration and large amplitude of the EMP transients. [Ref 16: pp. 10-12] The components which are most susceptible to lower thresholds of EMP damage are those being used extensively in today's state-of-the-art computers and

electronics. And of those components which will receive damage, the damage will usually take one of the following forms [Ref. 17: pp. 5-6, 5-7]:

**a. Dielectric Breakdown**

Dielectric breakdown occurs when voltages, ranging from 30 to 200 volts, are applied to the dielectric for a period long enough, usually one microsecond, to cause the layer to fail. A dielectric is a nonconducting layer which is used as an insulator between two conductors.

**b. Thermal Effect**

Thermal effect is caused by the dissipation of energy within a component due to excessive current flow. It is the major cause of semiconductor junction failure and resistor burnout.

**c. Interconnection Failure**

Interconnection failure results when induced electrical transients cause the component's temperature to increase to a sufficient level to cause metal surface connections to melt.

**2. Component Upset**

Component upset may be described as a temporary change in the operating characteristics of a circuit or component which results from the energy transients associated with an EMP. Again, refer to Figure 13 for an illustration of component upset. The circuit may return to normal operation

when the transient is removed, as with the saturation of an amplifier, or it may require an operator to reset it manually as with a tripped circuit breaker. The mission of the equipment may or may not be affected by the upset depending on its nature and extent. If the component suffers some type of permanent alteration, but is still able to function although at a reduced capability, the component is considered degraded. Degradation may be caused by long term exposure, about one microsecond, to EMP transients whose amplitude is insufficient to cause damage. [Ref 16: pp. 9-12]

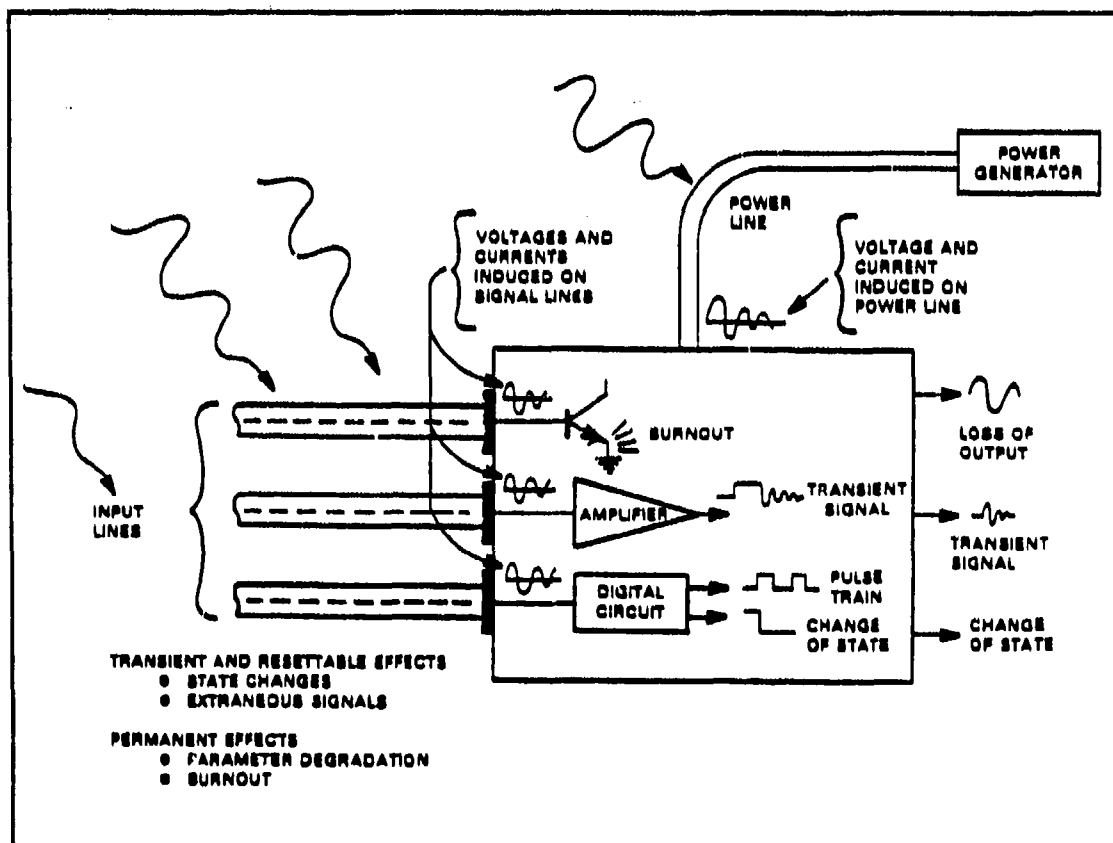

Figure 13. EMP Effects on Electronics

Although digital systems are more susceptible, component upset can occur in both analog and digital systems at as low as a few volts. The EMP can induce stresses into systems up to several thousands of volts. Generally, the energy required to cause component upset is a factor of 10 to 100 times lower than that required to cause component damage [Ref. 8: p. 10-28]. The upset occurs at low system stress levels when the system sees the EMP as a normal input and responds accordingly. A problem arises when the system response is not correct. For example, the system may cause a circuit to reset a flip/flop switch from on to off or vice versa. Or, the system's response may cause digital information to be read incorrectly as in the case of reading a zero as a one or a one as a zero. [Ref. 6: pp. 72-77] Because component upset can occur at such low voltage levels, there exists a potential for extensive system failures.

### **3. EMP Effects On Electrical Cables**

Electrical cables can suffer EMP damage when energy transients cause the cable voltage to exceed the cable insulation's threshold or breakdown voltage. The cable's breakdown strength is limited by the dielectric strength of small imperfections present in the insulation [Ref. 17: p. 5-25]. Cables which are already electrically stressed, such as transmission output cables, will be particularly susceptible to EMP transients when the difference between the voltage

supplied by the transmission and the voltage required to overload the cable is very small. Once the EMP's energy transients interact with the cable, the cable's insulation will quickly break down resulting in a cable failure. [Ref. 8: p. 10-28]

Buried cables offer some protection from the EMP's energy transients as the ground absorbs the high frequency portion of the energy. Unfortunately, the ground does not reflect all of the EMP and a portion of the incident field will be transmitted into the soil where it can induce current into the buried cables. Once the current is induced into the cable, it can be introduced into the system where it can cause component damage or upset. [Ref. 12: p. 1-27]

#### **D. RADIO BLACKOUT**

In addition to the physical damage and upset which the EMP can cause to communications equipment, it can also seriously degrade the propagation range for communications. Although the EMP can adversely impact the frequency range from 3,000 Hz to 3,000 MHz, it is particularly effective in the high frequency (HF) band and is sometimes referred to as "HF blackout." The HF band ranges from 3 to 30 MHz and is used extensively by the military for long range communications. This is achieved as the HF signals propagate from the transmitter to the receiver by successive reflections between the earth and various atmospheric layers.

A HEMP will generate an increase in the electron density of the atmosphere at different heights. This will cause a significant increase in the atmospheric absorption of some of the HF signals, and may cause a lowering of the altitude at which the signal is reflected. HF blackout may last from several seconds to several hours, and recovery will depend on the weapon's yield, height of burst, and the number of times the signal is reflected through the region of increased electron density.

Signals in the very high frequency (VHF) range, from 30 to 300 MHz, are used primarily for line-of-sight communications over short distances. VHF signals will be degraded through absorption as they pass through the region of increased electron density. Signal degradation will last on the order of minutes to tens of minutes.

The ultra high frequency (UHF) band, from 300 MHz to 3 GHz (3 billion hertz), is used for long range line-of-sight communications. Signals in the UHF range will experience degradation due to signal absorption in the area of increased electron density. This effect can be expected to last from seconds to minutes. [Ref. 5: pp. 461-490]

## **E. SUMMARY**

This purpose of this chapter has been to familiarize the reader with the way in which the EMP enters or couples with electrical and communications equipment. It then discussed



the harmful effects which the EMP has on the sensitive components which make up the equipment and the communications systems. Lastly, the chapter described the concept of radio blackout and how it degrades communications. The next chapter will discuss the measures that can be taken to minimize the effects of the EMP.

#### **IV. HARDENING EQUIPMENT TO THE ELECTROMAGNETIC PULSE**

##### **A. INTRODUCTION**

This chapter will discuss the concept of equipment hardening, or protection, as a means of making the equipment less susceptible to the harmful effects of an electromagnetic pulse (EMP). It will include both the requirements for hardening and the approach to hardening. It will then describe the various strategies for reducing the equipment's EMP environment and raising its threshold to EMP damage or upset.

It is important to remember that equipment which is protected from lightning or electromagnetic interference (EMI) is not adequately protected from the EMP. While some characteristics of the EMP may be similar to lightning, the high frequency component of an EMP is much greater than that of lightning. Therefore, additional hardening is required. EMI protection alone is inadequate because the amplitudes reached by an EMP are orders of magnitude greater than those generated by any EMI. [Ref. 13: p. 37]

##### **B. DEFINING HARDENING**

Hardening will be defined in terms of the requirements that have been determined necessary to protect electronic equipment from an EMP, as well as the approach taken. If the

hardening effort is to be effective, it must be continually evaluated and implemented at all levels within the system from equipment designer to operator.

#### 1. Requirements

The first part of the definition involves the process of accurately deciding if specific pieces of electronic equipment or systems will require EMP hardening, and it must include the consideration of many factors. Figure 14 displays the decision process that determines the hardening requirement [Ref. 6: p. 91]. The final decision of whether or not to harden will result after careful analysis of the factors to determine if the equipment meets the hardening requirement. One of the most important requirements to determine, but perhaps one of the most difficult, is if the equipment will be exposed to an EMP [Ref. 6: p. 90]. Certainly, equipment which will be employed within a combat area can reasonably be expected to be exposed to an EMP provided the enemy has a nuclear capability. Equipment which will be used exclusively within the continental United States is less likely to be exposed, unless there is a high altitude nuclear detonation like that described in Chapter II. Because EMP hardening increases the cost of equipment, it is not possible to harden all electronic equipment in a period of declining defense budgets.

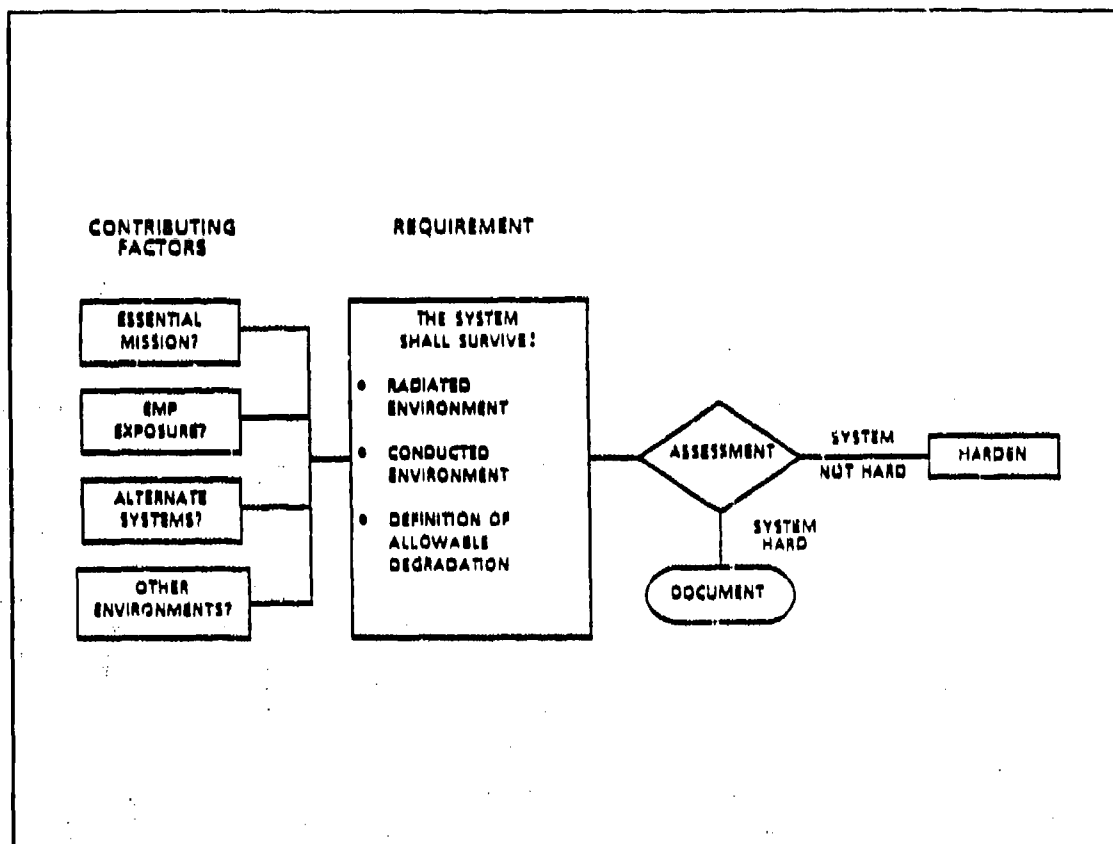

Figure 14. Major Hardening Requirement Decisions

A second important requirement, and one that is somewhat easier to determine, is whether or not the equipment performs an essential mission [Ref. 6: p. 90]. It can be argued that all electronic and communications equipment related to the employment of strategic nuclear weapons must be EMP hardened because it performs an essential mission in the defense of the nation and its forces. However, hardening all radio equipment down to the squad level may not be viewed as essential or practical based on the mission performed and the cost. If the cost of a hardened radio is more than the cost of buying an additional unhardened radio, then the decision

not to harden would appear to be acceptable given these considerations. This may be the case when the equipment requires an expensive retrofit to achieve hardening.

Equipment must be evaluated with respect to the EMP environment that it will be required to survive. Chapter III described both the radiated field and the conducted transient environments and how they affect electronic equipment. The type of EMP hardening required will depend on which environment the equipment will encounter. In determining the threat environment, it is known that electric and magnetic fields will be present in the radiated environment, and currents and voltages will be present in the transients induced on conductors. It may be necessary to harden the equipment to one or both of these harmful environments. [Ref. 6: p. 90]

The manner in which equipment is expected to respond after exposure to an EMP is another requirement that must be considered for hardening. The equipment's post-exposure response will depend not only on how long the EMP lasts, but on its magnitude as well. These factors will help determine whether the equipment's electronics are upset or damaged. If the equipment undergoes electrical upset, can there be any allowable downtime before recovery? If damage occurs, will loss of the equipment jeopardize the mission? Equipment that performs the highest level essential missions would require more hardening than equipment performing lower level missions.

The additional hardening should ensure that the equipment is not damaged and responds in the desired manner regardless of the duration and amplitude of the EMP. [Ref. 6: p. 90]

## **2. Approach To System Hardening**

The approach taken to solve the problem of system or equipment hardening is the second part of the hardening definition. Basically, it is centered around the two approaches that can be taken to achieve hardening. The two approaches are to reduce the incident EMP environment and/or increase the equipment's threshold. Both approaches will be discussed in detail in the following sections.

### **C. REDUCING THE EMP ENVIRONMENT**

This approach to the problem of hardening involves a determination of whether or not to protect the entire system or only those components that have the lowest threshold and are the most susceptible to EMP upset or damage [Ref. 6: p. 94].

#### **1. Strategy**

There are two strategies that can be used to reduce the EMP environment. The first involves the creation of one or more zones or barriers of protection around a component or system. An example of one zone protection would be the EMP shielding around a single component within a radio. An example of multiple zones of protection would include the shielding around a component, enclosed within a protective

equipment case, and housed within a hardened shelter. Figure 15 illustrates the multilevel barrier approach to system hardening [Ref. 18: p. 57]. Because conductors attenuate or lessen the electromagnetic waves, zonal barriers are generally constructed out of conductive material. The effectiveness of barriers or zones may be reduced by energy leakage into the equipment if all the penetrations and apertures required for power cables and various connections are not treated to prevent the intrusion of unwanted radiated energy. It must be remembered that a zone of protection will only be as strong as its weakest link. [Ref. 6: p. 98]

The second strategy for reducing the EMP environment is to design the electromagnetic topology of the system in such a way that all elements of the system are protected. This approach differs from the first strategy in that it usually entails connecting systems which are external to the first system. An example would be connecting one zone to a second zone via a shielded cable. If the connecting cable is unshielded, the entire system may be compromised through the intrusion of transients which can be induced on the metallic connecting cables. To reduce this threat, transient suppressors and filters are used at the penetrations to the protected components and in addition to shielded cables. [Ref. 6: p. 100]

The strategy utilized for the allocation of hardening resources considers several options. One possible use of

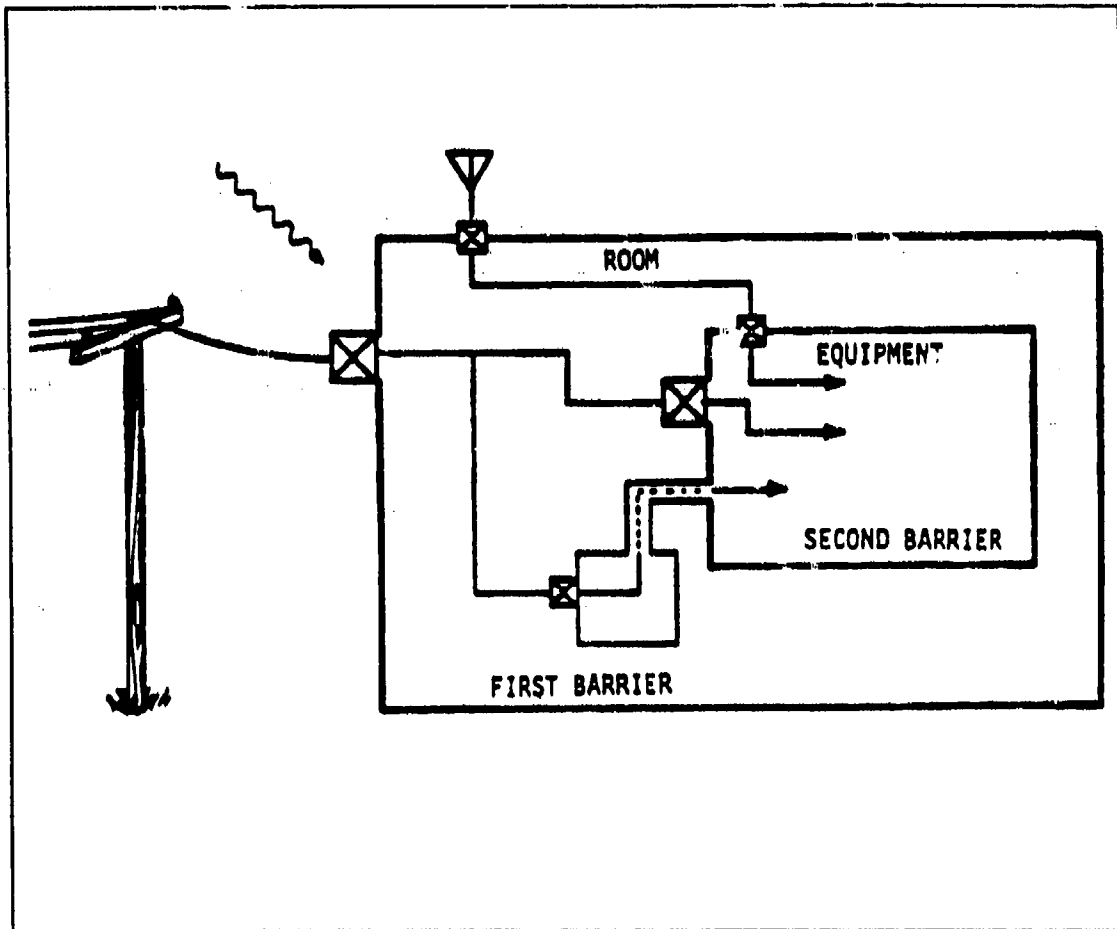

Figure 15. Multibarrier EMP Hardening

resources is for the creation of nested zones which are successively more tightly controlled to protect the internal electromagnetic environment from the EMP. Of course, this option increases costs and complicates the design of the system, but it does reduce the uncertainty of protection which results from the use of individual barriers. Further, multiple layers of protection add redundancy to the zones and make the system more robust. This is important for systems which perform essential missions. [Ref. 6: p. 102] A second



option is the use of one zone to protect all of the internal components. This approach permits the use of off-the-shelf, unhardened, and less expensive equipment within the barrier. If the barrier is compromised, all of the equipment contained within it can be adversely effected by the EMP. [Ref. 18: p. 58]

If hardening is considered when a system is designed rather than after it is fielded, it will permit more flexibility in the choice of a hardening technique as well as reduce costs and result in a less complex design. Simple, well-designed systems in which electronics are small and collocated are easier and cheaper to harden. [Ref. 6: p. 105]

## 2. Shielding

Equipment shields are used to protect sensitive electronic components from the EMP's harmful effects. Figure 16 illustrates the purpose of a shield [Ref. 18: p. 41]. To be effective, shields must be composed of conductive material to ensure hardening against both the electric and magnetic fields present in the EMP. Shields provide protection when the EMP's electric field causes charged particles within the conductive shield to move and rearrange themselves in response to the radiated field. This rearrangement results in the particles creating their own electric field which opposes the EMP's field. The opposing fields are equal in electric charge and tend to cancel each other. Unlike electric fields,

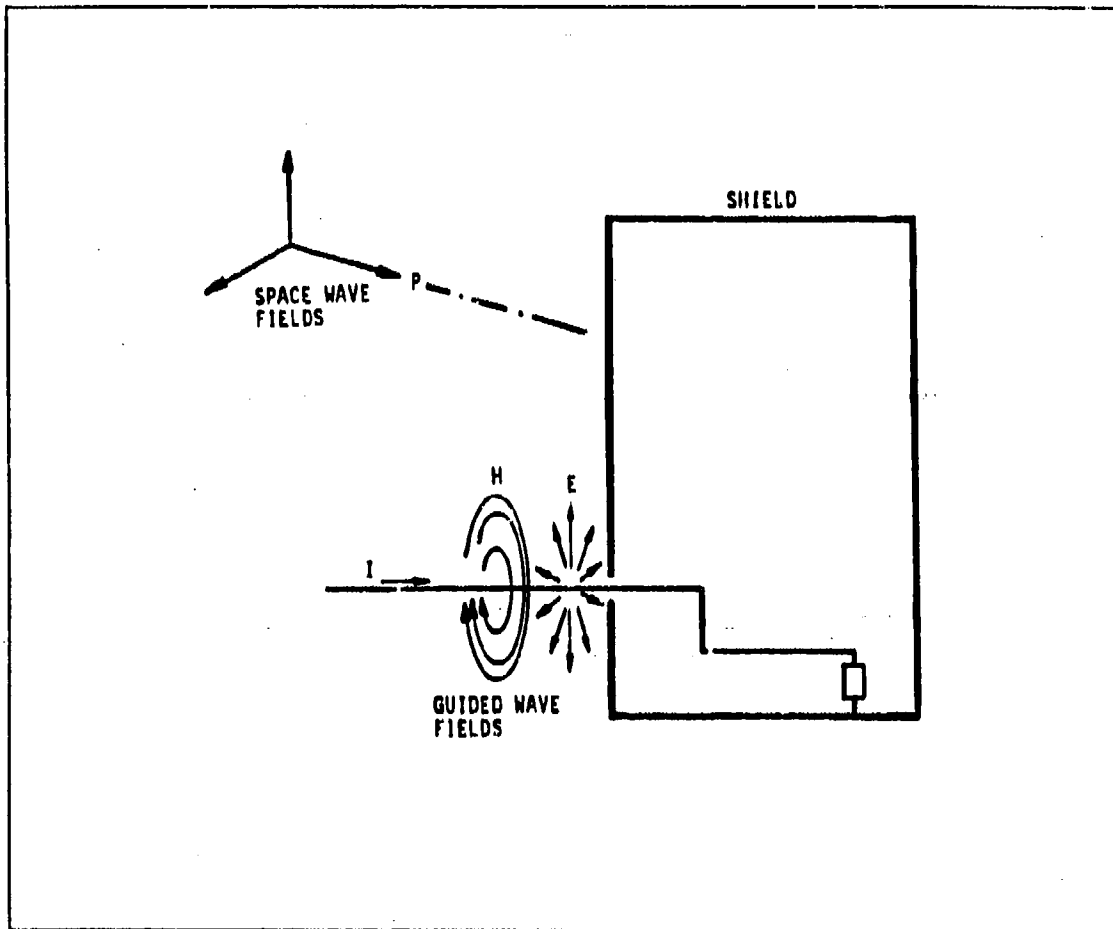

Figure 16. Effective Shields Exclude EMP

magnetic fields produce continuous current flows on the surface of the conductive shields. These current flows are opposed to the original magnetic field but are not strong enough to completely cancel the EMP's magnetic field unless the shields are made from a very good conductor, such as copper, and are of appreciable thickness. If weight is not a consideration for shielding, then an alternative to using a relatively light weight conductor like copper would be to use a ferromagnetic material such as iron. Ferromagnetic

materials provide good shielding properties because they have unbalanced currents flowing within their individual atoms. These atoms produce small magnets that rearrange themselves in opposition to the EMP's magnetic field which results in effective shielding. [Ref. 6: p. 106]

There are several characteristics found in materials that make good shields. The type of material used in the construction of the shield will play an important part in determining its effectiveness. Materials such as copper, aluminum, and steel are most often used to provide the best shielding based on their high electrical conductivity [Ref. 18: p. 39]. A shield's thickness will help establish its effectiveness in neutralizing magnetic fields. Material thicknesses of .25 millimeters are typically used to ensure protection from both electric and magnetic fields; however, if a ferromagnetic metal is used the thickness may be reduced [Ref. 18: p. 40].

All shields must be properly constructed in order to be efficient conductors. As discussed in Chapter III, if seams are not properly joined, stress, vibration, and corrosion will cause the shield to lose its connectivity. [Ref. 6: p. 108] Once this occurs, its effectiveness as a shield will be reduced and energy will be allowed to leak into the system and cause damage. Seam stress can be countered through the careful application of bonding or welding as required to join sections of a shield. The vibration of

tactical equipment is impossible to eliminate, but it can be reduced with the use of shock mounts in vehicular and mobile shelter mounted equipment. The proper and frequent cleaning of equipment shields can drastically reduce the effects of corrosion. Further, the use of sealants and compatible materials that are corrosion resistant will work to prevent a corrosion problem from developing [Ref. 19: p. 13-49].

### 3. Apertures

The proper treatment of apertures to reduce the EMP environment is important because all equipment requires apertures for access to operational controls and for maintenance. The approach to shielding will vary depending on the type of aperture. Access doors and display windows are considered here because they represent the types of apertures that are typically found on radio equipment. Access doors which are frequently opened are generally treated for hardening with the use of some type of closely spaced and overlapping metal flange. When the door is closed, the metal flange comes in contact with the metal door jamb to provide continuous connectivity and prevent energy leakage into the equipment. If the door is infrequently used such as a maintenance door, the best hardening technique to employ is securing the door with closely spaced screws. If this method is used, care must be taken to ensure that all of the screws are tightened to the same torque in order to prevent the door

from warping which would disrupt connectivity and permit energy to leak into the system.

Display windows can be effectively shielded by covering them with a metal screen that has its wires electronically connected to each other and to the surrounding shield. This permits electronic and magnetic fields to flow over the screen to prevent leakage. A stannous oxide coating can be used in place of a screen if long term exposure to the screen will become fatiguing or annoying to the operator. The coating method is usually more expensive than the metal screen covering. [Ref. 18: p. 53]

#### 4. Penetrations

Hardening penetrations is an integral part of reducing the EMP environment. Penetrations to equipment enclosures are made in order to connect the inside components of the equipment with additional external equipment, or to provide access to controls. An example of connecting an external piece of equipment would be a remote antenna connected to a radio. Although the radio may be EMP hardened, if both the antenna cable and the cable penetration are not treated, unwanted energy can leak into the radio. For some applications, fiber optic cable can be used to replace copper cable which acts like a conductor to collect EMP energy and deliver it to the radio's components. Fiber optic cable is particularly effective at reducing the EMP environment because

it is not susceptible to induced or radiated transients. [Ref. 18: p. 47] However, the user must ensure that the fiber optic cable does not have a metal element which is sometimes added by the manufacturer to increase tensile strength.

Fiber optics cannot be used for power cables, so power cables must be shielded. It is best to use double shielding on cables which may be exposed to an EMP in addition to the use of transient protection devices (TPD) at both ends of the cable where it enters the equipment. The TPD should then be shunted to ground at the equipment case. [Ref. 20: p. 76] The TPDs, or surge limiting devices, as they are often called are used to remove or attenuate (lessen) the harmful transients to an acceptable level. Some surge limiting devices such as spark gaps use amplitude to distinguish between desired and undesired signals. Undesired amplitudes can be the result of currents and voltages that are induced on cables. A spark gap is constructed of two electrodes that have a gap between them. When low, acceptable, voltage is passed through the spark gap, the device maintains an open circuit. If an unacceptably high voltage enters the gap, an arc forms across the gap and results in a short circuit. Variable resistors (varistors) and surge suppression diodes can be used to produce a similar result. [Ref. 6: p. 122]

To discriminate between desired and undesired signals based on frequency, filters are generally used. Undesired frequencies can be the result of transients. Filters are

designed to pass a band of either high or low frequencies. Generally, power lines are filtered to pass low frequencies, and transmission lines are filtered to pass high frequencies. [Ref. 18: p. 72] Systems that are required to perform essential missions, and those that cannot be allowed any downtime are typically outfitted with hybrid protection. Hybrid protection results from the use of combinations of TPD's such as spark gaps and filters. [Ref. 21: p. 4-6]

The actual penetrations are treated by sealing them closed around the cable or connector to maintain connectivity and prevent leakage. Whenever possible, the number of penetrations is reduced, and several cables are run through the same hole. Small, vacant penetrations can be treated by sealing the hole, or they can be protected by converting them into conductive tunnels. If the length of the tunnel is at least three to five times the diameter of the hole, it will act like a waveguide to strongly attenuate longer wavelength radiation and efficiently transmit short wavelength electromagnetic waves up to the cutoff wavelength. The tunnel method is effective because most of the EMP's energy has a wavelength of greater than three meters. Because the conductive tunnel has a much smaller diameter, the harmful EMP waves are attenuated. [Ref. 6: p. 116] Figure 17 is an excellent summary of the proper treatment of apertures and penetrations [Ref. 19: p. 13-29].

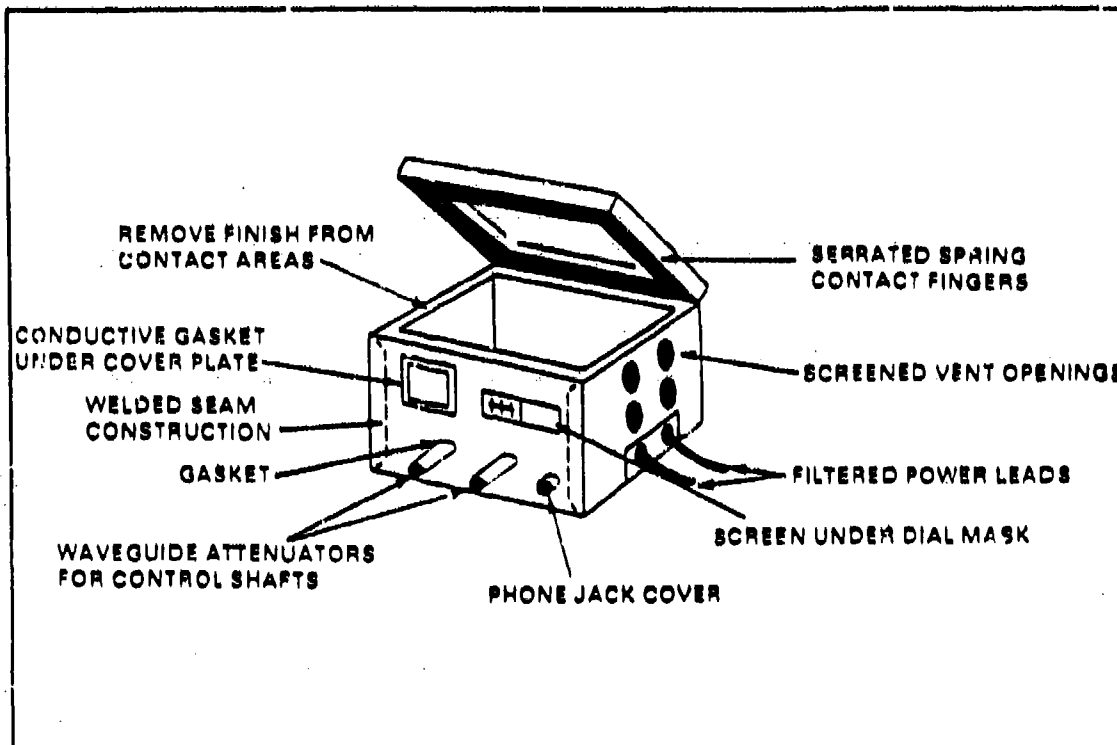

Figure 17. Effective Equipment Hardening

### 5. Grounding

Establishing a good single point ground for an electrical system is an essential part of protecting it from EMP upset and damage and is vital to reducing the EMP environment. Proper grounding provides the equipment with an intentional conductive path to earth where the energy transients can be harmlessly dissipated. A few important rules which should be adhered to when constructing a ground are to never penetrate barrier surfaces with a grounding conductor, and to never cross a barrier with a ground. [Ref. 12: p. 2-30] The rules of grounding and a sound grounding topology are displayed in Figure 18 [Ref. 18: p. 75].



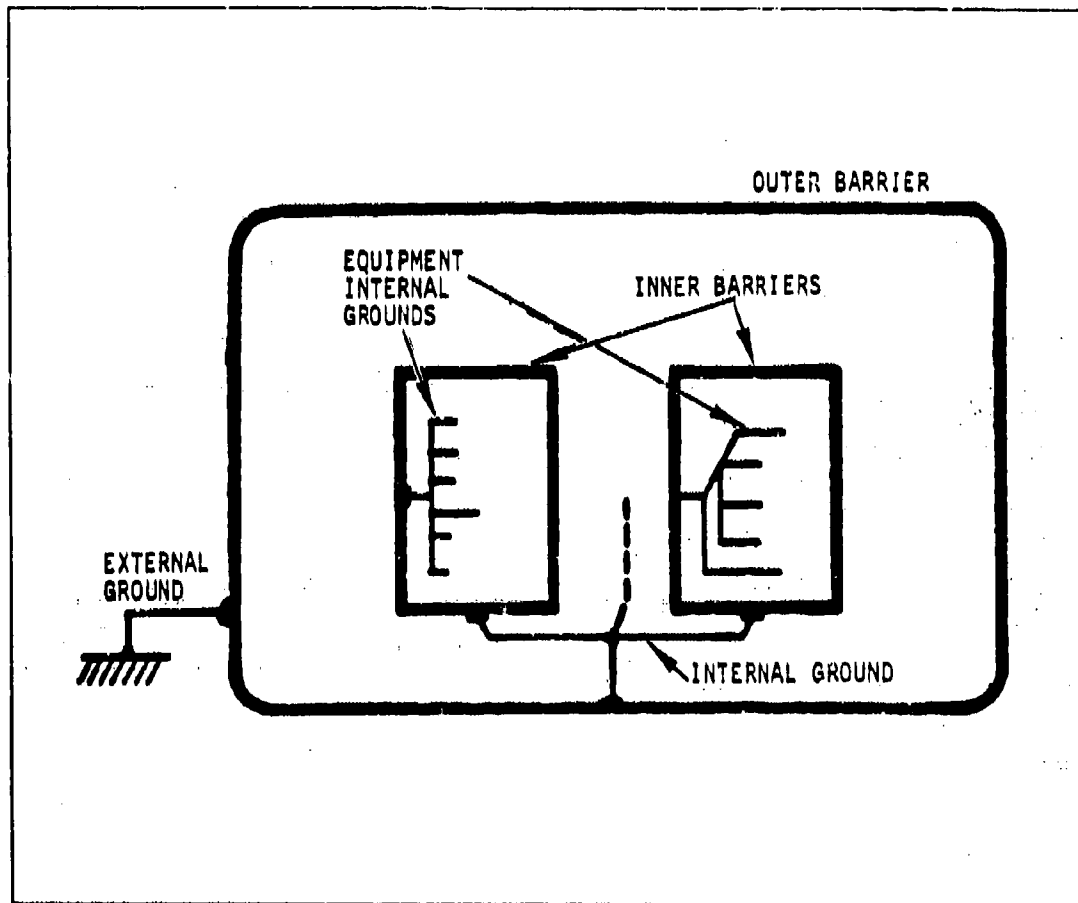

Figure 18. Grounding Topology

#### D. RAISING SYSTEM THRESHOLD

The second approach to system hardening involves raising the equipment's upset or damage threshold. The two strategies that are employed to accomplish this are component substitution and circuit redesign. Component substitution requires that the component most susceptible to failure be identified and replaced with one that has a higher threshold. Care must be taken to ensure that the equipment's sensitivity

is not decreased through the substitution. Further, increasing the threshold by too large a margin could jeopardize other components within the system.

Circuit redesign is accomplished at the component level through the use of filters, spark gaps, and diodes. Filters attenuate undesired frequencies and spark gaps remove or reduce harmful amplitudes. These devices are used to raise the equipment's threshold and make it more robust and less susceptible to an EMP. [Ref. 6: pp. 128-131]

## **E. SELECTING A HARDENING APPROACH**

The approach to hardening will depend not only on the nature of the system, but also on its stage in the life-cycle. For a system in the design stage of its life-cycle, hardening should take the form of internal shielding for components and collocating electronics to reduce the incident EMP environment. For systems that are already fielded, hardening should include some type of retrofit application of circuit redesign and component substitution to raise the system's threshold. The system's size, weight restrictions, and available space in which to include upgrades are important considerations to hardening in both new and existing systems.

The approach to hardening a new, fixed site communications shelter should be to emphasize reducing the EMP environment. This could be accomplished with the use of powerful EMP reduction methods such as heavy shielding because system

weight would not be a consideration. The number of apertures and penetrations should be reduced, and those that remained could be effectively treated to prevent leakage.

To harden a new aircraft, the manufacturer should not depend completely on reducing the EMP environment. The number of required apertures and penetrations would permit some leakage, and the weight and space limitations would restrict the amount of shielding. A significant effort should be made to increase the aircraft's threshold to EMP damage or upset.

The effort to harden a missile should center more on increasing the missile's threshold to upset or damage and less on reducing the EMP environment. This should be done because of weight and space restrictions and the fact that new missile designs are using low metal content composite materials which render shielding less effective.

A tactical radio has severe size, weight and available space limitations. Additionally, many of the new generation radios are housed in nonmetallic, nonconductive cases. For these reasons, there should be almost complete reliance on raising the system's threshold to accomplish hardening. [Ref. 6: p. 94]

In summary, selection of the proper hardening approach will ensure the following:

- The enclosure is of suitable material and thickness;
- Only necessary apertures and penetrations are present in the shield;

- All apertures are sealed or covered with protective screens or coatings;
- Vacant penetrations are sealed or converted to conductive tunnels;
- Electrical connections and cables are shielded and grounded; and,
- Filters and surge suppressors are installed on all nongroundable (fiber optic) cables. [Ref. 22: p. 3-28]

#### **F. FIELD PROTECTIVE MEASURES**

There are several protective measures that an equipment operator in the field can initiate to guard electronic equipment from an EMP. The following actions may be time and personnel intensive and should be implemented before the threat of an EMP is received:

- Ensure all shelter doors, vents, and access panels are closed and sealed.
- Place all extra equipment in a sealed shelter or shielded enclosure.
- Unroll excess cables that are connected to equipment to avoid inducing currents.
- Bury cables at least one foot in the ground to minimize energy transients.
- Use non-metallic guy lines and antenna supports.
- Use single point earth grounds.

The following actions should be initiated as soon as practicable after a nuclear burst warning is received:

- Disconnect all deliberate and nondeliberate antennas;
- Disconnect all nonmission essential equipment and place it in a hardened shelter or below ground level;

• Discontinue use of commercial power. [Ref. 9: p. 2]

These measures do not offer any protection for equipment which must continue to operate in an EMP environment. However, their implementation will help to ensure that equipment is operational after the EMP and able to perform its mission.

#### **G. SYSTEM TESTING**

Once a system is hardened either through initial design or retrofit, the hardening must be periodically tested to ensure that it retains the capability to protect the system from the harmful effects of an EMP. The requirement exists for systems to have integrated operational EMP testing in order to maintain a reasonable confidence in the system's ability to withstand exposure to EMP transients and still perform its mission. A system's level of EMP protection cannot be validated by inspection or analysis. Properly designed systems must be tested in a facility capable of validating their EMP hardness. Ground mobile systems are generally tested in a high level free-field simulator. [Ref. 23: p. 20]

Three types of EMP testing are used to evaluate system hardness. The first type of test is low-level current mapping. This is used at the beginning of a test program. With system power turned off, it is exposed to a low-level current environment. The test determines if the signatures and magnitudes of internal cables are within specifications. After corrections are made, the second test conducted is a

high-level current injection test. For this test, power is supplied to the system, and it is injected with a high-level current to determine system effects. If the system passes the second test, it undergoes the final test which is the high-level electromagnetic field test. In this test, waveform simulation or continuous wave signal, or both will be used depending on the system characteristics to be tested. [Ref. 5: pp. 527-529]

#### H. SUMMARY

This chapter described the main considerations of equipment hardening which are required to protect it from an EMP. The two main approaches to hardening are reducing the EMP environment and raising the system's threshold to upset of damage. The approach undertaken will depend on careful consideration of several factors and may include elements of both approaches. The next chapter will assess the benefit of EMP hardening and its associated costs.

## **V. ELECTROMAGNETIC PULSE HARDENING: COSTS AND BENEFITS**

### **A. INTRODUCTION**

The previous chapter described the various strategies and techniques used to achieve equipment hardening. Hardening is undertaken to protect electronic equipment from the damage that can result from an electromagnetic pulse (EMP). To achieve EMP hardening, certain costs must be considered and met. Figure 19 is a preview of the topics which will be discussed as this chapter identifies the costs of EMP hardening [Ref. 18: p. 227]. This chapter will discuss the benefits of hardening and present items for consideration in a cost/benefit analysis.

### **B. ESTIMATING EMP HARDENING COSTS**

Once the decision is made to EMP harden an electronic or communications system, the system designer is faced with a number of available hardening alternatives from which to choose. The alternatives range from a basic barrier-level protection design to complex component selection and construction materials and techniques. A prime consideration that the cost-conscious designer must not forget is that the EMP protection scheme that offers the lowest cost may not provide the best protection. In fact, the low cost solution may prove to be the least cost effective in certain EMP

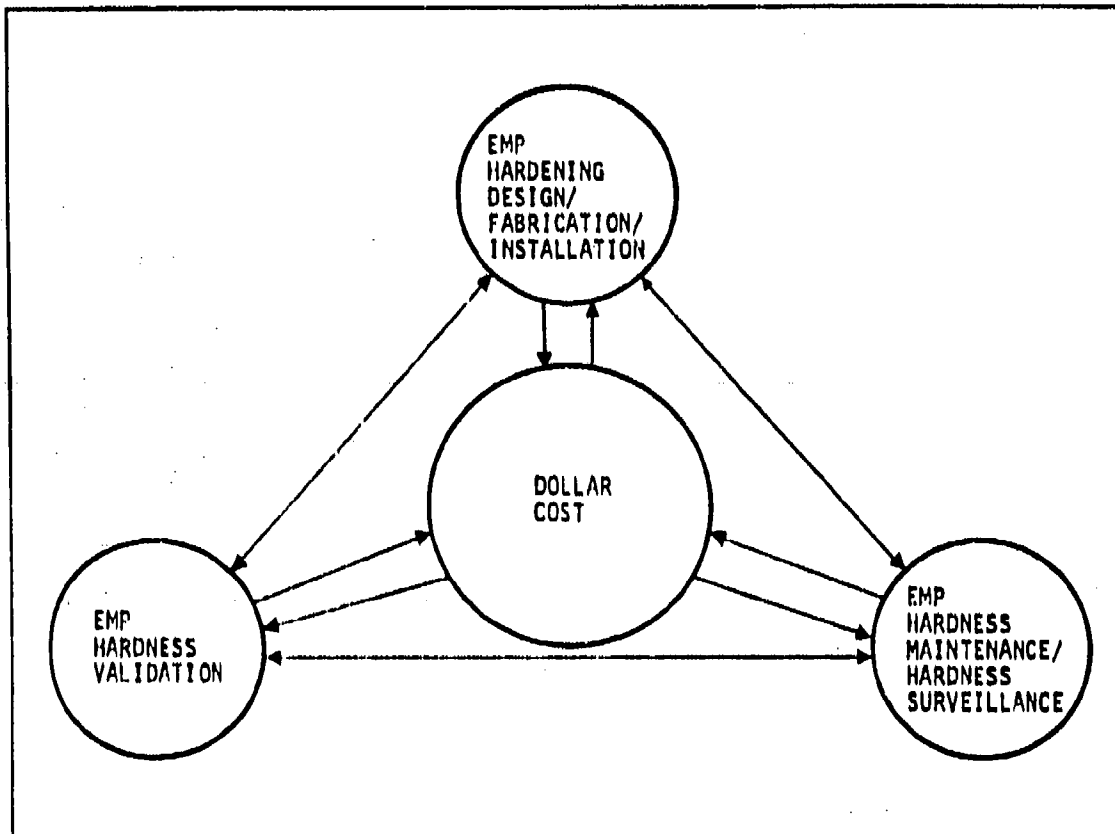

**Figure 19. EMP Hardening Cost Considerations**

environments. To select the hardening approach that is most cost effective, the program sponsor, in conjunction with the designer, must initiate and maintain a diligent cost awareness effort as part of the design and development process. Cost awareness involves estimating and tracking all costs associated with the hardening effort and understanding what determines those costs. Once the costs are estimated, the projections can be used to compare alternative hardening approaches in an effort to arrive at the most cost effective solution. [Ref. 18: p. 02-226]



The process of estimating EMP hardening costs can vary from the use of a simple percentage of total system cost to a highly complex algorithm that requires the input of numerous variables. For example, it is estimated that the cost to EMP harden a tactical radio to a 95 percent probability of survival is about two percent of the total cost of the system. For systems that require a higher probability of survival, the hardening costs will be significantly higher. However, a small increase in EMP protection can buy a large margin of extra confidence in the survivability of the system. [Ref. 14: pp. 309-310]

If the system is designed to protect against all of the harmful environments created during a nuclear detonation, including the EMP, the cost of hardening can range from one to ten percent of the total system cost for research, development, testing, and evaluation, and from one to five percent for unit production. [Ref. 13: p. 49] From these estimates, it is evident that even using a basic percentage approach to calculate total system cost for EMP hardening will add a significant amount to the system's total cost. More accurate cost estimates, but not necessarily less expensive ones, should result from the proper use of sophisticated cost projection models.

### C. TACTICAL SYSTEM LIFE CYCLE COSTS

The total cost of a tactical system from its inception to its retirement is referred to as the life cycle cost (LCC) of the system. As can be expected, several elements go into the calculation of a system's LCC. Although the following list is not all inclusive, it does represent a good example of most of the LCC factors that are considered for the hardness assurance, maintenance, and surveillance of tactical systems:

- Identifying the threat;
- Testing (surveillance);
- Research and development;
- Manufacturing and production;
- Training and personnel; and,
- Development and production of support equipment. [Ref. 24: p. 20]

A brief summary of the cost effect that these factors can have on an electrical system is provided in the following sections.

#### 1. Identifying the Threat

The costs associated with identifying the threat are those costs that accrue from determining the type of EMP that the equipment can reasonably be expected to be exposed to. The EMP types would include both the radiated electric field and induced current environments. The earlier in a system's life cycle that the EMP threat can be identified, the earlier that countermeasures can be incorporated into the system's design and the lower the cost of hardening the system.

EMP hardening measures that are undertaken after a system is fielded are always more expensive than measures that were taken when the system was originally designed. To help identify the threat, examine the particular mission that the equipment is to perform, and determine how essential that performance is to achieving success in the overall mission. Equipment which is essential to mission success will generally cost more to harden as redundancy and additional EMP protection is designed into critical components and built into the system. [Ref. 24: pp. 21-22]

## 2. Testing (Surveillance)

Testing a system's susceptibility to an EMP is a difficult and expensive process. The cost of testing will depend on the number of tests to be conducted and the criteria of testing [Ref. 12: p. 3-17]. New systems are tested to ensure that they meet EMP hardening specifications, and fielded systems are tested and inspected to ensure hardness is maintained and does not deteriorate with age and use. EMP testing cannot be accomplished with the detonation of actual nuclear devices, therefore, the Department of Defense has invested millions of dollars in the development and construction of EMP simulators. The U.S. Air Force has an EMP simulator that can test an entire aircraft for the effects of EMP, and the Navy has a simulator that can evaluate a ship's susceptibility to the effects of an EMP. Ground-based systems

are usually tested in a "field" environment after all of the necessary pre-production EMP testing is completed and before the system is fielded for use. Testing costs are estimated early in the system's life cycle and include post-deployment testing as well. [Ref. 24: p. 22]

### **3. Research and Development**

The research and development effort involved with EMP hardening can be very costly for new systems and for upgrading existing systems. If new technology is developed, research costs alone will account for a significant part of the system's total LCC. Lower research costs can be realized if existing "off-the-shelf" technology can be employed. The majority of research and development costs will result from efforts to counter the EMP threat previously identified. [Ref. 24: p. 22]

### **4. Manufacturing and Production**

Establishing a manufacturing facility, if necessary, and tooling-up for full scale production can represent part of the very expensive start-up costs associated with a new system. In addition to capital investments, the people who will be required to operate the production process must be hired and trained. Low volume production runs and the unnecessary use of expensive EMP hardened subassemblies and components which do not contribute to the equipment's overall protection will increase the per-unit cost of hardened

systems. A good up-front design effort is important to minimize manufacturing and production costs. [Ref. 24: pp. 22-23]

### **5. Training and Personnel**

The costs associated with training personnel will depend on the number of systems to be fielded and the complexity of the system design. The training requirement will include operators, technicians, and support personnel. Costs can include the development of a training program, materials, and facilities. [Ref. 24: p. 33] It may be necessary to hire new personnel, and the cost of this effort must also be included.

### **6. Development and Production of Support Equipment**

EMP hardened equipment can require the use of special tools and procedures for its repair and maintenance. Many of these specialized tools will be developed and manufactured after production of the system they are designed to support. If required, this effort can significantly increase the cost of a hardened system as new production facilities and support are developed. [Ref. 24: p. 23]

Although most operators do not consider the cost of the EMP hardened communications equipment that is used to support military operations, it is important to recognize the various cost factors that makeup the system's LCC. Once this is accomplished, an effort can be made to reduce those costs

at each stage of a system's life cycle. The communicator can have a significant impact on reducing the repair and replacement costs of equipment through the proper maintenance, operation, and employment of tactical systems. Proper maintenance of equipment will ensure that it sustains its capability to minimize the harmful effects of an EMP. Equipment that is operated in accordance with the manufacturer's specifications for frequency, power output, and antenna selection will be less susceptible to component damage or upset from an EMP. The employment of equipment within an EMP environment that it is not designed to tolerate will diminish or destroy the equipment's ability to perform its mission.

#### **D. STATIONARY SYSTEM LIFE CYCLE COSTS**

All of the cost factors associated with EMP hardening for tactical systems also apply to stationary systems. Additionally, there are costs associated with the requirement for stationary systems to have relatively large, fixed-plant facilities that require hardening. Initially, there is the cost of implementing the design to harden the facility and the cost of materials and labor. Other costs will include all of the efforts that go into hardening the facility's apertures and penetrations to protect against EMP leakage, and the cost of the shielding which surrounds the building to create an EMP-resistant barrier. The use of filters for power and

telephone lines and any hardening required to protect the system's antennas will add significantly to hardening costs [Ref. 12: pp. 3-10 and 3-11].

Additional costs associated with the facility will include surveillance costs such as tests, inspections, and evaluations to ensure that adequate EMP protection is maintained. Costs that result from the surveillance effort are the cost of periodic repairs and scheduled maintenance as well as operations and maintenance costs that can be directly attributed to the facility's EMP hardening. [Ref. 7: p. 4-31] Finally, stationary facilities are frequently required to maintain a stock of EMP hardened replacement equipment which can result in large inventory costs. [Ref. 25: p. 3-6]

#### **E. LIFE CYCLE COST CONSIDERATIONS**

Determining the actual cost that EMP hardening adds to a system is a difficult and time consuming process. Often, the actual cost can not be fully calculated until the system is in operation. Even then, continuing maintenance and surveillance costs must be added to the system's LCC until the total cost can be calculated when the system is retired.

Program managers need some mechanism for making a rough approximation of a system's total LCC for use in financial planning and budget submissions in the beginning phases of a system's life cycle. This can be accomplished if the historical budget data of similar EMP hardening programs is

used to predict the various LCC considerations that a typical program will encounter. Using this basis, three major cost considerations are identified and can be evaluated. [Ref. 25: p. 3-6]

### 1. Acquisition Costs

It can be estimated that approximately 28 percent of the system's total LCC will derive from acquisition costs. The acquisition costs will be broken down as follows:

- 12% for design;
- 72% for fabrication;
- 14% for installation and evaluation; and,
- 2% for documentation.

### 2. Operation Costs

Operation costs will account for about 12 percent of the total LCC. These costs result from the following factors:

- 68% for personnel; and,
- 32% for petroleum, oil, and lubricants.

### 3. Logistic Support Costs

The largest percentage of LCC can be attributed to logistic support costs. These costs account for approximately 60 percent of the total cost and include the following:

- 92% for recurring logistic support costs. This includes roughly 20% for replenishment spares, 10% for repair materials, and 70% for repair labor costs.
- 8% for support investments. Support investments are calculated based on an average of 8% for initial training, 25% for age, and 67% for initial spares.



Of course, the above figures are to be used only for initial cost estimates. As the EMP hardening program becomes better established, more accurate LCC estimates can be achieved. [Ref. 25: p. 3-7]

#### **F. EMP HARDENING BENEFITS**

The major benefit that is derived from EMP hardening can be summed-up in one word, "survivability." EMP hardening significantly increases the probability that equipment will survive an EMP environment and continue to perform its mission both during and after exposure to an EMP. Having electronic and communications equipment that is operational in a post-EMP environment is critical to mission accomplishment and overall success for the tactical commander on the battlefield.

On a larger scale, the ability of early warning and defense systems to withstand a HEMP and continue to operate and respond to commands is essential to national security. The command and control system of the National Command Authority is dependent on EMP-survivable electronic and communications equipment for the control and employment of the nation's military to include strategic nuclear weapons. EMP hardening helps to ensure that these systems are available for use as a deterrent or for defense should it become necessary.

## **G. COST/BENEFIT ANALYSIS**

The cost/benefit analysis is based on the cost of EMP hardening compared to the benefits which result from having hardened equipment. There are several approaches that can be taken when conducting a cost/benefit analysis, and the approach that is used will be determined by the event being measured. In this section, two approaches that are applicable to EMP hardening will be discussed. They are the probability model and the cost effectiveness model. It is important to remember that these models result in very subjective analysis. This subjectivity results from the answers that are obtained to difficult questions such as what cost and benefit factors will be considered, and how will those factors be measured. Further, the calculations that would be made are based on items that are difficult to quantify such as intangible benefits like the number of lives that would be saved and the feeling of security that would result from EMP hardening.

[Ref. 26: pp. 73-100]

### **1. Probability Model**

In this model for the development of a cost/benefit analysis, the probability of a system's exposure to an EMP is calculated. The calculated probability is based on the likelihood of a nuclear detonation in a particular area. The area under consideration may be a small battlefield in some remote corner of the world or the entire United States. The

resulting probability will depend on the particular scenario under evaluation, and the likely result will be a range of probabilities corresponding to the number of scenarios evaluated. [Ref. 27]

Once the probability of exposure to an EMP is determined, the cost of protecting equipment from the EMP is calculated. Typical hardening costs include the following:

- Purchase and installation of shielding to include the treatment of apertures and penetrations;
- Shielded cables, filters, and EMP hardened components and subassemblies;
- Antenna treatments and special grounding requirements;
- Additional costs associated with circuit design, the EMP hardening method utilized, and the margin of protection required; and,
- Other life cycle costs specific to hardening.

It is important to note that the cost considered involves more than the dollar amount associated with hardening and all of the cost factors previously discussed. The cost also includes such things as the ability to pay and the cost of other goods and services that must be sacrificed to pay for hardening. For example, if a particular radio system is EMP hardened, the increased cost due to hardening may drastically reduce the quantity of radios that can be purchased. And if reducing the number of radios to be purchased is not an option, then budget cuts may have to be made in other acquisition programs in order to divert funds to the radio purchase. These are some of the difficult decisions that

program managers and acquisition specialists must make, and they use the cost/benefit analysis as an aid in the decision making process.

Measuring the potential benefits of an EMP-hardened system is not too difficult for the following example. A combat unit is able to utilize its EMP-hardened radio equipment during and after exposure to an EMP. Because of this, the unit completes its mission, and the lives of countless men are saved. A second benefit, and one that is more difficult to quantify, is the feeling of security that results from knowing that the equipment is EMP-hardened, and that it will continue to operate in an EMP environment.

Once the costs and benefits of hardening are totaled, they are compared to the probability of exposure to an EMP. A decision maker then determines if the cost of hardening is justified when the probability of an EMP and the benefits of hardening are considered.

## **2. Cost Effectiveness Model**

The cost effectiveness model is more narrowly defined than the probability model. In this approach, one vital communications link or system is considered rather than all of the assets in a particular area. First, the cost of EMP hardening for a particular system is calculated. The costs are basically the same as those considered in the probability model. Next, alternate methods of ensuring that the system

will be available for use in the event of an EMP are evaluated. Alternate methods may include non-EMP hardened redundant systems or the use of EMP resistant transmission methods and media such as microwave and fiber optic cable. The decision maker then determines the most cost effective approach to ensuring that the system remains viable in an EMP environment. The benefits of maintaining an operational system will depend on the importance of the system being evaluated. In general, the benefits are the same as those considered in the probability model and may even include increased national security when critical, high level systems are evaluated. [Ref. 27]

Few people would argue against a reasonable expenditure for EMP hardening given the benefits that result. However, the benefit side of the argument does not outweigh the cost side in every case. The question that arises is whether or not all electronic and communications equipment requires hardening. The ideal answer is yes, provided the cost can be met. In the present economic environment of fiscal austerity and budget cuts, the real answer is no. Therefore, the question becomes which pieces of equipment require hardening and in what numbers. Once this question is evaluated and answered, a total cost can be estimated. It is then up to the national leadership to decide if the potential benefits of EMP hardening exceed the costs.

## H. SUMMARY

This chapter began by presenting an overview of the methods used to estimate the cost of EMP hardening. It then identified and described the major cost considerations for EMP hardening for both tactical and stationary systems. The chapter also discussed life cycle cost considerations and the benefits of EMP hardening. The chapter closed with a description of costs and a discussion of two cost/benefit analysis models. Chapter VI follows and is the final chapter of this thesis. It contains a brief summary of recent world events as they pertain to the material presented in this thesis and conclusions regarding EMP hardening and training.

## VI. SUMMARY AND CONCLUSIONS

### A. SUMMARY

In recent years, we have seen that major events which impact the entire world tend to occur so rapidly that one can hardly keep pace. Such is the case as it pertains to this thesis. When this thesis was begun, the world order was much as it had been since the conclusion of World War II. The principal adversary of the United States was the Soviet Union, and America's defenses were based on the Soviet threat. The Soviet Union was in some ways a "comfortable" enemy in that America's military planners knew what they could expect from them in the way of hostile action both through direct Soviet action and through their intervention and influence in third world nations. It was common knowledge that the Soviet Union had nuclear weapons and a delivery system capable of placing those weapons in America's heartland. Because of this, efforts were made to counter the nuclear threat. One result was development of the World Wide Military Command and Control System (WWMCCS). This system is designed to give the national leadership early warning in the event of a Soviet first strike. The system is also used to control the nation's conventional and nuclear defense assets. It is WWMCCS that would have carried the National Command Authority's order to

counterattack a Soviet missile launch. However, this essential system is composed of electronic and communications components without which the system could not function. If these components are not hardened, they are susceptible to the harmful effects of an EMP.

One possible attack scenario was the high altitude detonation of a sizeable nuclear device about 300 kilometers above northeast Kansas, as discussed in Chapter II. The resulting HEMP from this type of detonation would affect the entire continental United States. As discussed in Chapter III, unprotected electronic and communications equipment would experience component upset or damage, and it was postulated that America's defense system would be rendered useless. The Soviet army would then march in and "bury us" as Soviet Premier Nikita Khrushchev had predicted in the early 1960's. While this scenario may seem unrealistic, consider a plan that was rumored to have been evaluated by the U.S. military during the recent Gulf War. In it, a nuclear device would be detonated at a suitable altitude over Iraq for the purpose of generating a HEMP that would cripple Iraq's command and control system and power distribution network. If the plan was legitimate, it was never executed. One reason may have been because Iraq made extensive use of fiber optic cable which is not affected by the EMP. In any case, the HEMP threat that existed when this thesis was begun has now been greatly reduced by the demise of the Soviet Union.



## B. CONCLUSIONS

Because this nation's command and control systems, such as WWMCCS, are so dependent on electronic equipment, they are susceptible to EMP damage and/or upset if they are not EMP hardened. Efforts that were made to protect mission essential equipment should not be abandoned. But with the collapse of the Soviet Union, some would argue that the nuclear threat that the United States has been exposed to for the last forty years has been severely reduced if not eliminated, and a HEMP is no longer a threat. This may be true concerning the large, long range nuclear weapons because other nations do not currently possess the necessary delivery vehicles. However, nuclear weapons and their resulting EMP are still a threat. In addition to several nations attempting to develop a nuclear capability, there is the growing threat of exposure to an EMP from the detonation of a tactical nuclear weapon that is obtained by a radical third world country like Libya or Iraq. And there is always the possibility of some fanatical terrorist group obtaining one or more low yield nuclear devices and detonating them for the purpose of disrupting America's defense network. It is for these reasons that, at a minimum, mission essential electronic and communications equipment must continue to be protected against an EMP. The EMP threat has been reduced, but not totally eliminated.

Military personnel who work in the field, and particularly those who operate, maintain, and employ electronic and

communications equipment, should be made aware of what the electromagnetic pulse is and the actions they can initiate to protect their equipment from an EMP.

## LIST OF REFERENCES

1. Broad, W. J., "The Chaos," Science, January/February, 1983.
2. Middlestead, R. E., LeLevier, R. E., and Smith, M. D., "Satellite Crosslink Communications Vulnerability in a Nuclear Environment," IEEE Journal on Selected Areas in Communications, v. SAC-5, February 1987.
3. Clark, A. W., "High Altitude Nuclear Burst Effects," paper presented to Professor O. Heinz, Naval Postgraduate School, Monterey, California, 18 December 1986.
4. Defense Nuclear Agency, DNA-H-86-68-V2, DNA EMP Course Study Guide, Vol. 2: Detailed Discussion, by P. Dittmer and others, 27 May 1986.
5. Glasstone, S., and Dolan, P. J., The Effects of Nuclear Weapons, 3rd ed., U.S. Department of Defense and U.S. Department of Energy, 1977.
6. Defense Nuclear Agency, DNA-H-86-68-V1, DNA EMP Course Study Guide, Vol. 1: Overview, by P. Dittmer and others, 27 May 1986.
7. Defense Nuclear Agency, DNA-H-86-60-V1, DNA EMP Engineering Handbook for Ground Based Facilities, Vol. 1: Program Management, by J. Burson and others, 15 November 1986.
8. MIL-HDBK-419A, 21 January 1982.
9. Fiedler, D. M., "Protecting Against Electromagnetic Pulse," Army Communicator, Summer, 1987.
10. Fisher, F. A., and Plumer, J. A., Lightning Protection of Aircraft, Lightning Technologies Inc., 1990.
11. C3I Report, Vol. 2, No. 7, 6 April 1987.
12. Defense Nuclear Agency, DNA-H-86-60-V2, DNA EMP Engineering Handbook for Ground Based Facilities, Vol. 2: Design and Engineering, by J. Burson and others, 15 November 1986.

13. U. S. Army Materiel Development and Readiness Command, HDL-TR-1882-I, Nuclear Weapons Effects on Army Tactical Systems, Vol. I: Overview, by J. J. Halpin and others, April 1979.
14. Carter, W. W., "EMP: What it is and What to do About it," Signal, June 1984.
15. Trippe, A. P., "The Threat of Electromagnetic Pulse," National Defense, December 1984.
16. Defense Nuclear Agency, DNA-TR-84-371, Design Guidelines for Mitigation of EMP Effects on Electronic Circuits, by E. E. Donaldson Jr. and others, 31 October 1986.
17. Defense Nuclear Agency, DNA 2772T, DNA EMP Awareness Course Notes, Third Edition, by I. N. Mindel, October 1977.
18. Naval Facilities Engineering Command, High Altitude Electromagnetic Pulse Protection for Ground Based Facilities, Design Manual 12.02, October 1986.
19. Phelps, R., and Ali, A. S., "Electromagnetic Pulse Protection Short Course," Revision 2, prepared for the Department of Physics, Naval Postgraduate School, Monterey, California, 1987.
20. Press, J. L., "EMP Response of a Generic Groundbased Facility," 1990 International Symposium on Electromagnetic Compatibility, Symposium Record, August 1990.
21. Kalab, B., "Terminal Protection Devices for EMP Survivability," Nuclear Survivability, December 1987.
22. Defense Nuclear Agency, DNA-H-86-60-V4, DNA EMP Engineering Handbook for Ground-Based Facilities, Vol 4: Low Risk Protection, by L. Albright and T. Zwolinski, 31 December 1987.
23. Baker, G. H., "High Altitude EMP Hardness Validation Testing Approach," Nuclear Survivability, February 1991.
24. Defense Nuclear Agency, DNA-TR-89-281, Military Handbook for Hardness Assurance, Maintenance, and Surveillance (HAMS) Planning, by C. Thompson and R. Beaty, September 1990.

25. Defense Nuclear Agency, DNA-H-86-60-V3, DNA EMP Engineering Handbook for Ground Based Facilities, Vol. 3: Facility Operation and Maintenance, by E. M. York and H. G. Reed, 15 November 1986.
26. Prest, A. R., and Turvey, R., "The Main Question," in Cost-Benefit Analysis, Ed. Richard Layard, Penguin Modern Economics Readings, 1976.
27. Interview between W. R. Gates, Adjunct Professor of Economics, Naval Postgraduate School, Monterey, California, and the author, 22 January 1992.

### INITIAL DISTRIBUTION LIST

	No. Copies
1. Defense Technical Information Center Cameron Station Alexandria, Virginia 22340-6145	2
2. Library, Code 52 Naval Postgraduate School Monterey, California 93943-5002	2
3. Commandant of the Marine Corps Code TE 06 Headquarters, U.S. Marine Corps Washington, D.C. 20380-0001	1
4. Superintendent Naval Postgraduate School Attn: Professor Dan C. Boger, Code AS/Bo Monterey, California 93943-5000	1
5. Superintendent Naval Postgraduate School Attn: LtCol D. E. Summers, Code 037 Monterey, California 93943-5000	1
6. Commanding General Marine Corps Logistics Base Attn: Mr. Harrell, ILSD (Code 841-4) Albany, Georgia 31704-5000	1
7. Commanding General MCRDAC Attn: Captain S. J. McGrath Quantico, Virginia 22134-5000	1